

# DISHWASHERS

## SOLO SERVICE MANUAL



**SERIES Y**

## TABLE OF CONTENTS

1. INTERFACE AND HARDWARE.....	4
1.1 Y SERIES W/O DISPLAY(Y11, Y12, Y13,Y14, Y15).....	4
1.2 Y SERIES W DISPLAY-W/O DIVERTER(Y1A, Y1B, Y1C,Y1D, Y1E, Y1F) .....	4
1.3 Y SERIES W DISPLAY-W/ DIVERTER(Y21, Y22, Y23,Y24).....	5
2. WASHING PROGRAM .....	7
2.1 WASHING PROGRAM CROSS TABLE .....	7
2.2 PROGRAMME SEQUENCES .....	8
3. WASHING SPECIFICATIONS AND PROGRAMS .....	10
3.1 SELECTING AND STARTING PROGRAM AT POWER ON(BEFORE PROGRAM STARTS) .....	10
3.2 OPENING AND CLOSING DOOR(BEFORE PROGRAM STARTS) .....	12
3.3 OPENING AND CLOSING DOOR DURING PROGRAM(NOT IN DRY STEPS) .....	12
3.4 OPENING AND CLOSING DOOR DURING PROGRAM(IN DRY STEPS) .....	14
3.5 OPENING AND CLOSING DOOR DURING PROGRAM(IN REGENERATION FIRST STEP) .....	14
3.6 OPENING AND CLOSING DOOR DURING PROGRAM(IN REGENERATION SECOND STEP) .....	15
3.7 SELECTING AND STARTING PROGRAM WHEN DOOR IS OPENED(BEFORE PROGRAM STARTS)	16
3.8 TERMINATION OF A PROGRAM(END OF PROGRAM).....	17
3.9 CANCELLING OF A PROGRAM(DURING PROGRAM).....	17
3.10 IF USER PRESSES ANY BUTTON(AT THE END OF PROGRAM) .....	18
3.11 MODIFICATION OF A PROGRAM WITHOUT RESET.....	18
3.12 MODIFICATION OF A PROGRAM WITH RESET .....	19
3.13 SWITCH OFF THE MACHINE DURING PROGRAM AND BEFORE STARTING PROGRAM .....	20
3.14 SWITCH OFF THE MACHINE DURING PROGRAM AND AFTER STARTING PROGRAM .....	20
3.15 CANCELLING OF A PROGRAM (DURING DELAY TIME).....	21
3.16 MODIFICATION OF A PROGRAM DURING DELAY TIME.....	22
3.17 SWITCH OFF THE MACHINE DURING DELAY TIME .....	23
4. POWER FAIL.....	24
5. OPTIONS .....	24
5.1 OPTIONS & MODELS.....	24
5.2 COMPATIBILITY BETWEEN OPTIONS .....	26
5.3 COMPATIBILITY BETWEEN OPTIONS & PROGRAMS.....	26
5.4 OPTION DEFINITION .....	28

5.4.1	Delay Timer.....	29
5.4.2	Half Load.....	30
5.4.3	Tablet (for models with display).....	30
5.4.4	Child Lock.....	30
5.4.5	Extra Options (for models w/ display).....	31
6.	SOFTWARE REQUIREMENTS.....	32
6.1	HEATER .....	32
6.2	WATER FILL .....	32
6.3	WATER DRAIN.....	32
6.4	REGENERATION CYCLE.....	33
6.5	FEATURE OF TIME PHASE .....	34
6.6	VOLTAGE SENSING CONTROL.....	35
6.7	NTC VALUES.....	36
6.8	WATER HARDNESS SET .....	37
7.	SERVICE TEST .....	40
7.1	SERVICE FAILURE CODES .....	47
8.	FAILURE ROUTINES.....	48
8.1	DESCRIPTION OF FAILURES.....	49
8.2	FAILURE CODES.....	54
9.	END TEST .....	56
10.	MODIFICATION HISTORY OF DOCUMENT .....	58
11.	ELECTRICAL COMPONENTS.....	58
11.1	MEASUREMENT OF COMPONENTS.....	61
12.	DISASSEMBLE.....	80

# 1. INTERFACE AND HARDWARE

## 1.1 Y SERIES W/O DISPLAY(Y11, Y12, Y13,Y14, Y15, Y14\_AU,Y13\_7,Y15\_7,**Y1X\_W**(60CM)

The user interface includes:

- Program button
- Program status with Wash, Rinse, Dry and End leds / Program numbers with 4 leds
- Start/Stop and Reset button with 1 led
- Delay and Half Load button with integrated led(Half Load led)
- Delay durations with 2 leds
- On/Off button with integrated led
- Rinse aid and Salt leds

*Note: Wash, Rinse, Dry, End leds also corresponds to program numbers P1, P2, P3, P4, P5 and P6 as shown below.*

P1: Wash      P3: Dry      P5: Wash+Rinse  
 P2: Rinse      P4: End      P6: Dry+End

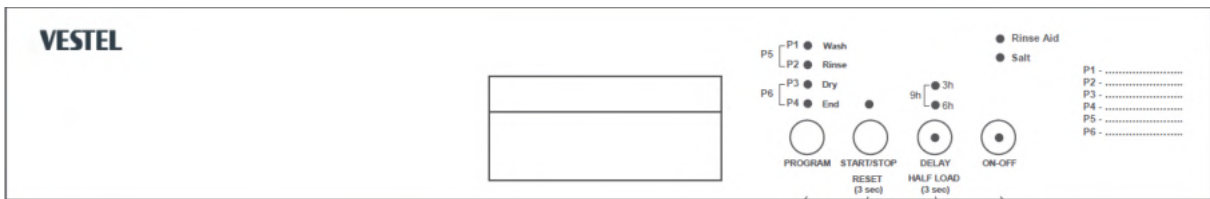

### Y14 au

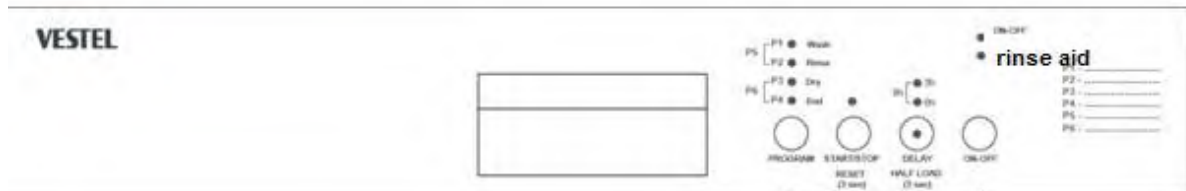

## 1.2 Y SERIES W DISPLAY-W/O DIVERTER(Y1A, Y1B, Y1C,**Y1X\_W**(60CM),Y1D, Y1E, Y1F, Y1D\_AU, Y1C\_7, Y1E\_7)

The user interface includes:

- Display including Wash, Rinse, Dry and End leds + 3 digits + Program button + Start/Stop/Reset button
- Extra button with 3 leds(Hygiene led, Rinse led, Dry led)
- Delay button with 1 led(Delay led)
- Options button with 2 leds (Half load led, Tablet led)
- On/Off button with integrated led
- Rinse aid and Salt leds





Y11d AU:



### 1.3 Y SERIES W DISPLAY-W/ DIVERTER(Y21, Y22, Y23,Y24,Y21\_7,Y22\_7,Y23\_7,Y24\_7)

The user interface includes:

- Display including Wash, Rinse, Dry and End leds + 3 digits + Program button + Start/Stop/Reset button
- Extra button with 3 leds(Hygiene led, Rinse led, Dry led)
- Delay button with 1 led(Delay led)
- Half load and Tablet option button with integrated led
- Upper Basket led
- Lower Basket led
- On/Off button with integrated led
- Rinse aid and Salt leds



### 1.4 Y SERIES W DISPLAY-W/ DIVERTER-W/BLDC - W/ADO(Y25,Y25\_7)

The user interface includes:

- Display including Wash, Rinse, Dry and End leds + 3 digits + Program button + Start/Stop/Reset button
- Extra button with 3 leds(Energy Save, Fast, Silent)
- Delay button with 1 led(Delay led)
- Half load and Tablet option button with integrated led
- Upper Basket led
- Lower Basket led
- On/Off button with integrated led
- Rinse aid and Salt leds





### 1.5 Y SERIES W DISPLAY-W/ DIVERTER-W/BLDC(Y26)

The user interface includes:

- Display including Wash, Rinse, Dry and End leds + 3 digits + Program button + Start/Stop/Reset button
- Extra button with 3 leds(Drying, Fast, Silent)
- Delay button with 1 led(Delay led)
- Half load and Tablet option button with integrated led
- Upper Basket led
- Lower Basket led
- On/Off button with integrated led
- Rinse aid and Salt leds

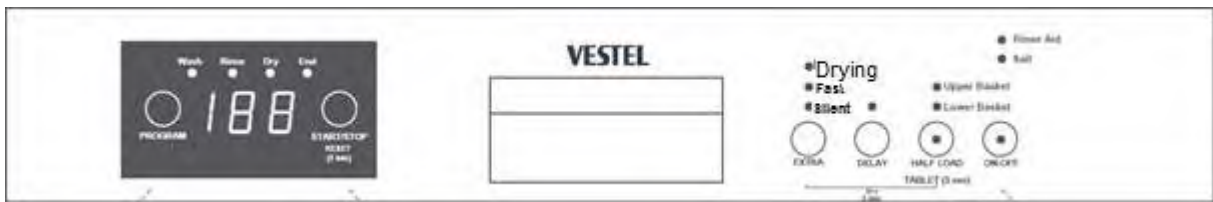

### 1.4 USA MODELS

#### USA - WITHOUT DIVERTER

USA 45-60cm YA1-...-YA7 models with salt tank:

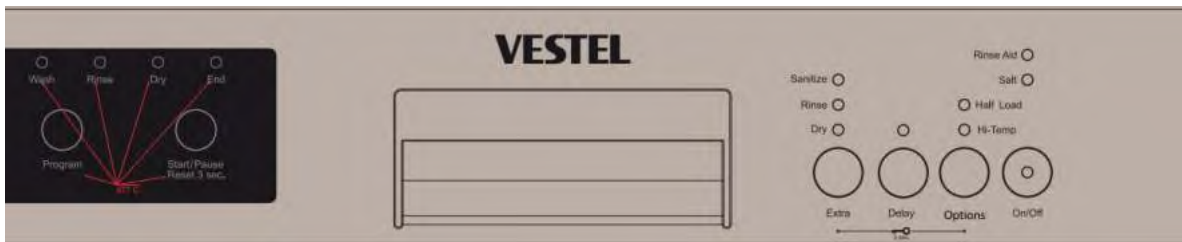

USA 45-60cm YA1-...-YA7 models without salt tank:

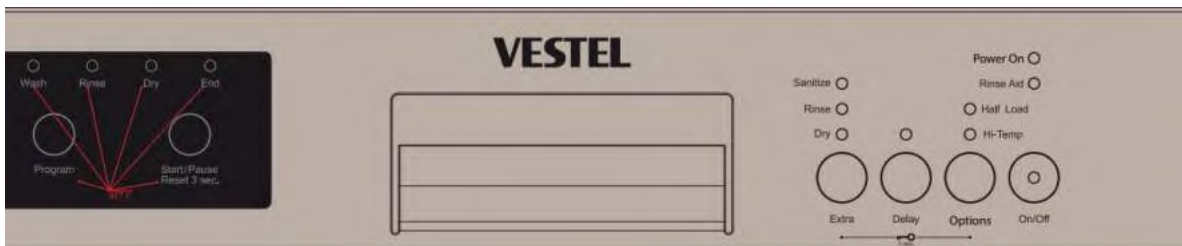

USA - WITH DIVERTER

USA 45-60cm YB1-..-YB7 models (Asynchronous) with salt tank:



USA 45-60cm YB1-..-YB7 models (Asynchronous) without salt tank:

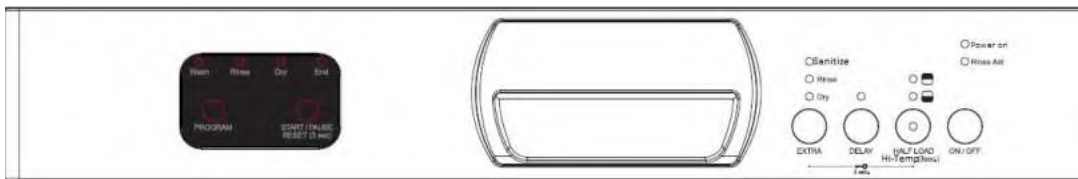

USA 45-60cm YB5-YB6-YB7\_B (BLDC) models with salt tank:



USA 45-60cm YB5-YB6-YB7\_B (BLDC) models without salt tank:

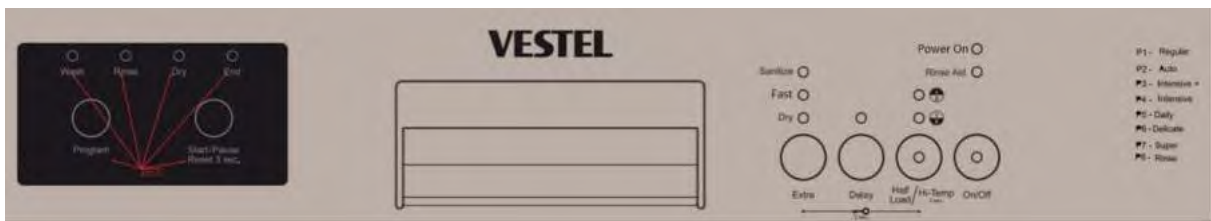

**2. WASHING PROGRAM**

**2.1 WASHING PROGRAM CROSS TABLE**

MODEL	JETWASH	PREWASH	QUICK 30'	ECO 50 °C	Regular W.	SUPER 50' 65°C	DELICATE 40°C	INTENSIVE 65°C	+INTENSIVE PLUS	DAILY 60°C	DUAL PRO WASH 60°C	HYGIENE 70°C	NORMAL 55°C	AUTO DELICATE 30°C-50°C	AUTO NORMAL 50°C-60°C	AUTO INTENSIVE 60°C-70°C	STEAM WASH	AUTO
Y11				X				X										
Y12				X		X		X										
Y13			X	X		X		X										
Y14			X	X		X	X	X										
Y15/W	X	X	X	X		X	X	X										
Y1A				X				X										
Y1B				X		X		X										

Y1C			X	X		X		X										
Y1D			X	X		X	X	X										
Y1E		X	X	X		X	X	X										
Y1F/ W		X	X	X		X	X	X		X								
Y21		X	X	X		X	X	X										
Y22		X	X	X		X	X	X		X								
Y23		X	X	X		X	X	X		X			X					
YB7		x			x	x	x	x	x	x								x
Y24		X	X	X		X				X				X	X	X	X	
Y25	X	X	X	X		X					X	X				X	X	
Y26	X	X	X	X		X					X	X				X	X	

## 2.2 PROGRAMME SEQUENCES(45cm and 60cm)

Programme Number	Y11	Y12	Y13	Y14	Y15/W
P1	Eco 50°C	Eco 50°C	Quick 30'	Quick 30'	Prewash
P2	Intensive 65°C	Super 50'	Eco 50°C	Delicate 40°C	Quick 30'
P3	-	Intensive 65°C	Super 50'	Eco 50°C	Delicate 40°C
P4	-	-	Intensive 65°C	Super 50'	Eco 50°C
P5	-	-	-	Intensive 65°C	Super 50'
P6	-	-	-	-	Intensive 65°C

Programme Number	Y1A	Y1B	Y1C	Y1D	Y1E	Y1F/W
P1	Eco 50°C	Eco 50°C	Quick 30'	Quick 30'	Prewash	Prewash
P2	Intensive 65°C	Super 50'	Eco 50°C	Delicate 40°C	Quick 30'	Quick 30'
P3	-	Intensive 65°C	Super 50'	Eco 50°C	Delicate 40°C	Delicate 40°C
P4	-	-	Intensive 65°C	Super 50'	Eco 50°C	Eco 50°C
P5	-	-	-	Intensive 65°C	Super 50'	Daily 60°C
P6	-	-	-	-	Intensive 65°C	Super 50'
P7	-	-	-	-	-	Intensive 65°C

Programme Number	Y21	Y22	Y23	Y24	Y25	Y26
P1	Prewash	Prewash	Prewash	Prewash	Prewash	Prewash
P2	Quick 30'	Quick 30'	Quick 30'	Quick 30'	Jetwash 14'	Jetwash 14'
P3	Delicate 40°C	Delicate 40°C	Delicate 40°C	Eco 50°C	Quick 30'	Quick 30'

<b>P4</b>	Eco 50°C	Eco 50°C	Eco 50°C	Daily 60°C	Eco 50°C	Eco 50°C
<b>P5</b>	Super 50'	Daily 60°C	Normal 55°C	Super 50'	Super 50'	Super 50'
<b>P6</b>	Intensive 65°C	Super 50'	Daily 60°C	Auto Delicate	Dual Prowash	Dual Prowash
<b>P7</b>	-	Intensive 65°C	Super 50'	Auto Normal	Hygiene 70°C	Hygiene 70°C
<b>P8</b>	-	-	Intensive 65°C	Auto Intensive	Auto Intensive	Auto Intensive
<b>P9</b>	-	-	-	Steamwash	Steamwash	Steamwash

Note:Y26\_7 model is not available yet.

### 2.3 PROGRAMME SEQUENCES (45cm and 60cm without diverter USA)

Programme Number	YA1	YA2	YA3	YA4	YA5	YA6	YA7
<b>P1</b>	Regular	Regular	Regular	Regular	Regular	Regular	Regular
<b>P2</b>	Auto	Auto	Auto	Auto	Auto	Auto	Auto
<b>P3</b>	-	Super	Intensive	Intensive	Intensive	Intensive	Intensive Plus
<b>P4</b>	-	-	Super	Super	Delicate	Daily	Intensive
<b>P5</b>	-	-	-	Rinse	Super	Delicate	Daily
<b>P6</b>	-	-	-	-	Rinse	Super	Delicate
<b>P7</b>	-	-	-	-	-	Rinse	Super
<b>P8</b>	-	-	-	-	-	-	Rinse

### 2.4 PROGRAMME SEQUENCES (45cm and 60cm with diverter USA)

Prog Number	YB1	YB2	YB3	YB4	YB5	YB6	YB7	YB5_BL DC*	YB6_BL DC*	YB7_BL DC*
<b>P1</b>	Regular	Regular	Regular	Regular	Regular	Regular	Regular	Regular	Regular	Regular
<b>P2</b>	Auto	Auto	Auto	Auto	Auto	Auto	Auto	Auto	Auto	Auto
<b>P3</b>	-	Super	Intensive	Intensive	Intensive	Intensive	Intensive Plus	Intensive	Intensive	Intensive Plus
<b>P4</b>	-	-	Super	Super	Delicate	Daily	Intensive	Delicate	Daily	Intensive
<b>P5</b>	-	-	-	Rinse	Super	Delicate	Daily	Super	Delicate	Daily
<b>P6</b>	-	-	-	-	Rinse	Super	Delicate	Rinse	Super	Delicate
<b>P7</b>	-	-	-	-	-	Rinse	Super	-	Rinse	Super
<b>P8</b>	-	-	-	-	-	-	Rinse	-	-	Rinse

### 3. WASHING SPECIFICATIONS AND PROGRAMS

#### 3.1 SELECTING AND STARTING PROGRAM AT POWER ON(BEFORE PROGRAM STARTS)

When the dishwasher is switched on,

**For models w/o display;**

COMMANDS	Start/Stop	Wash	Rinse	Dry	End	On/Off
Switch on	ON	OFF	OFF	OFF	OFF	ON
Select program	ON	ON/OFF*	ON/OFF*	ON/OFF*	ON/OFF*	ON
Pressure of Start/Stop button	OFF	ON	OFF	OFF	OFF	ON

\*When user selects a program related program led(s) is ON. After pressing Start/Stop button, related program led(s) is OFF, Wash led is ON.

Ex1: User presses On/Off button to switch on the dishwasher. On/Off led, Start/Stop led and Eco programme leds are ON .

Next, selects P1 by pressing program button once. P1(wash) led, Start/Stop led and On/Off led are ON.

Then, user presses Start/Stop button. Wash led and On/Off led are ON, Start/Stop led is OFF. Rinse, Dry and End leds are OFF. Machine is in washing step.

When the machine passes to rinse step, Rinse led and On/Off led are ON. Wash, Dry and End leds are OFF.

When the machine passes to dry step, Dry led and On/Off led are ON. Wash, Rinse and End leds are OFF.

When the program finished, End led and On/Off led are ON. Wash, Rinse and Dry leds are OFF.

Ex2: User presses On/Off button to switch on the dishwasher. On/Off led and Start/Stop led are ON. Next, selects P2 by pressing program button twice. P2(rinse) led, Start/Stop led and On/Off led are ON.

Then, user presses Start/Stop button. Wash led and On/Off led are ON, Start/Stop led is OFF. Rinse, Dry and End leds are OFF. Machine is in washing step.

When the machine passes to rinse step, Rinse led and On/Off led are ON. Wash, Dry and End leds are OFF.

When the machine passes to dry step, Dry led and On/Off led are ON. Wash, Rinse and End leds are OFF.

When the program finished, End led and On/Off led are ON. Wash, Rinse and Dry leds are OFF.

**For models w/ display;**

COMMANDS	Wash	Rinse	Dry	End	On/Off	Digit
Switch on	OFF	OFF	OFF	OFF	ON	3" program number and 1" duration of default program are shown alternately
Select program	OFF	OFF	OFF	OFF	ON	3" program

						number and 1" duration of program are shown alternately
Pressure of Start/Stop button	ON	OFF	OFF	OFF	ON	Duration of program

- Default program is "Eco program".

- When the dishwasher is powered off and on again the last executed program and options are not visualized on screen anymore. Each energized of the machine, Eco program is set as default.

Note(Y25 & Y26): When user selects program, 3" program number, 1" program hour, 1" program minute are shown alternately. (Ex1: Eco program will be shown respectively as P4, 3h, 59) (Ex2: Prewash program will be shown P1 , 15) (Ex3: Program duration will proceed as ..., 1h 02, 1h 01, 1h, 59 ,58,...)

**FOR USA MODELS:**

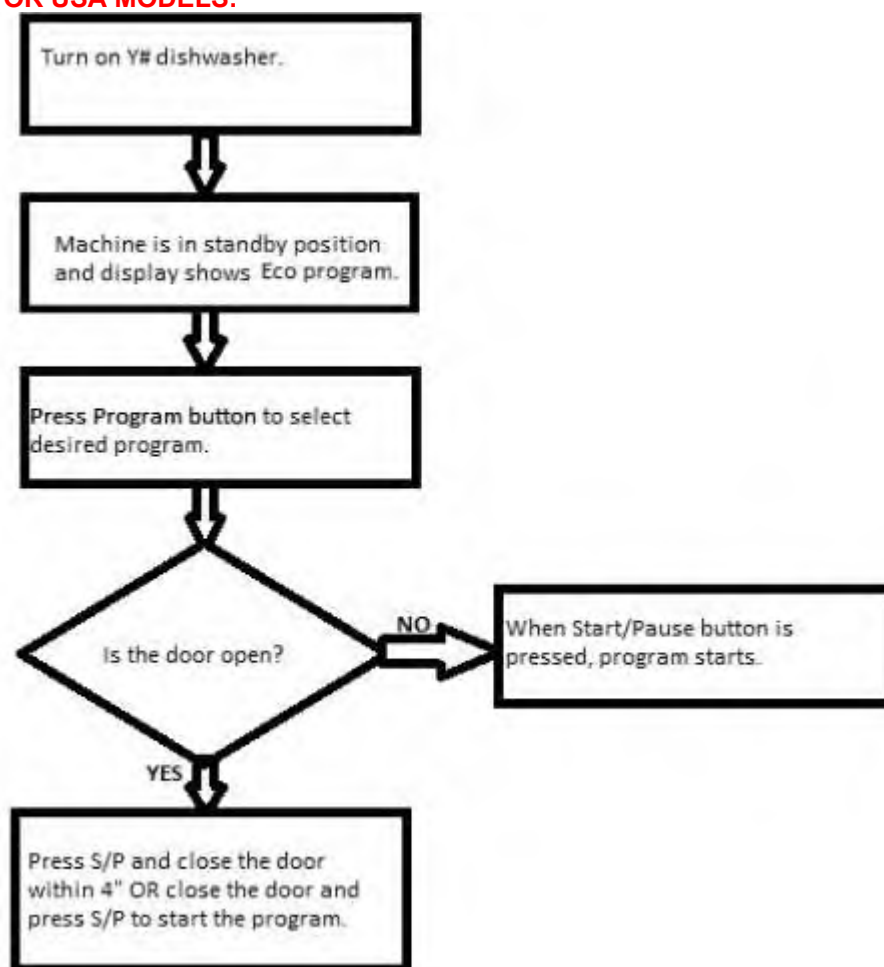

**For USA models 4 seconds rule:** To start the selected program or delay timer, press Start/Pause button and close the door within 4 seconds. If the door is not closed within 4 seconds after Start/Pause button pressed, program / delay timer will be paused. **During this 4 seconds, display counts down from 4 to 1.**

**USA modeller için 4 saniye kuralı:** Seçilen programı ya da ertelemeyi başlatmak için Start/Pause butonuna basıldıktan sonra 4 saniye içerisinde kapı kapatılmalıdır. Eğer 4 saniye içerisinde kapı kapatılmazsa program / erteleme pause edilir. **Bu 4 saniye boyunca displayde 4'ten 1'e doğru geri sayım yapılır.**

### 3.2 OPENING AND CLOSING DOOR(BEFORE PROGRAM STARTS)

**For models w/o display;**

COMMANDS	Start/Stop	Wash	Rinse	Dry	End	On/Off
Door open	ON	OFF	OFF	OFF	OFF	ON
Door closed	ON	OFF	OFF	OFF	OFF	ON

**For models w/ display;**

COMMANDS	Wash	Rinse	Dry	End	On/Off	Digit
Door open	OFF	OFF	OFF	OFF	ON	3" program number and 1" duration of default program are shown alternately
Door closed	OFF	OFF	OFF	OFF	ON	3" program number and 1" duration of default program are shown alternately

### 3.3 OPENING AND CLOSING DOOR DURING PROGRAM(NOT IN DRY STEPS)

During the program if the door is opened and re-closed without any modifications on the program button and without the pressure of Start/Stop button, the program continues. Washing program re-starts after 8" if the measured temperature is equal or more than 45°C.

**For models w/o display;**

COMMANDS	Start/Stop	Wash	Rinse	Dry	End	On/Off
Door open	Blink	ON/OFF*	ON/OFF*	OFF	OFF	ON
Door closed	OFF	ON/OFF	ON/OFF	OFF	OFF	ON

\*When the door is opened, related washing step led is ON together with the blinking Start/Stop led.

**For models w/ display;**

COMMANDS	Wash	Rinse	Dry	End	On/Off	Digit
Door open	ON/OFF	ON/OFF	OFF	OFF	ON	Duration of program pauses, 3" program number and 1" duration of program are shown alternately
Door closed	ON/OFF	ON/OFF	OFF	OFF	ON	Duration of program resumes

When the door is opened, program is paused and digit blinks.

Not: Y1X\_W modelleri için kural aşağıdaki gibi olacaktır.

- Program çalışırken; kapı açılıp tekrar kapandığında veya elektrik gidip tekrar geldiğinde, ürün direk programa kaldığı yerden devam etmez (pause moduna geçsin). müşteri start pause butonuna ekstradan bir kere basar ve program devam eder.

Also, for Y1X\_W models, program starts only after door is closed and then start/pause is pressed to start program.If user presses Start/Pause button and then close the door, program cannot start.

#### FOR USA MODELS:

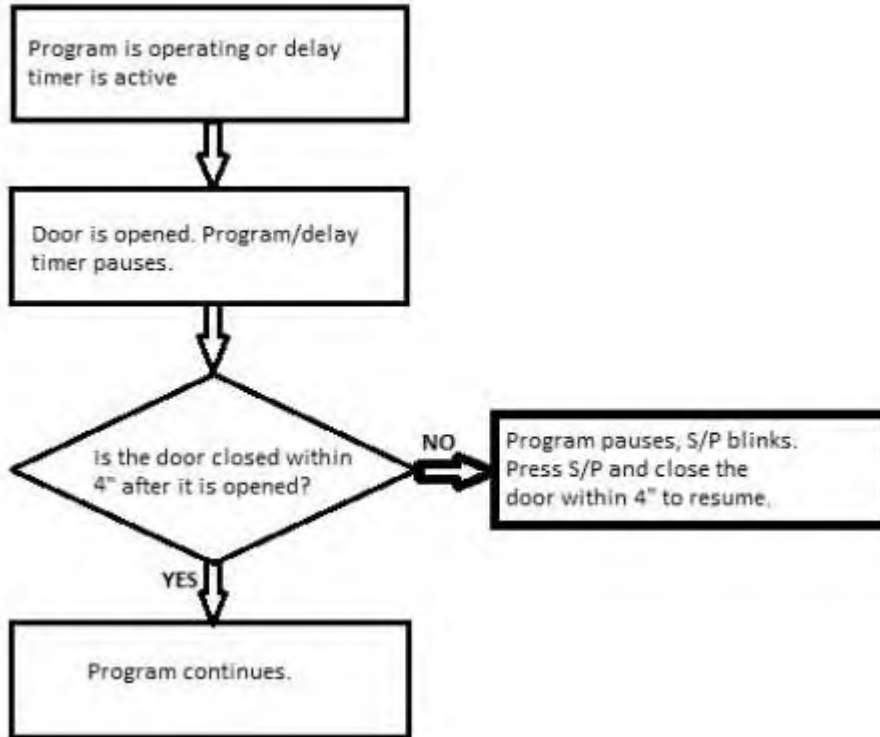

**For USA models 4 seconds rule:** During the program washing or delay timer is active, if the door is opened and re-closed within 4 seconds program / delay timer resumes. If the door is not closed within 4 seconds after the door is open, program / delay timer will be paused. **During this 4 seconds, display counts down from 4 to 1.**

**USA modeller için 4 saniye kuralı:** Yıkamadayken ya da erteleme aktif olduğu sırada kapı açılıp daha sonra 4 saniye içerisinde kapatılırsa program / erteleme kaldığı yerden çalışmaya devam eder. Eğer 4 saniye içerisinde kapı kapatılmazsa program / erteleme pause edilir. **Bu 4 saniye boyunca displayde 4'ten 1'e doğru geri sayım yapılır.**

### 3.4 OPENING AND CLOSING DOOR DURING PROGRAM(IN DRY STEPS)

During dry step: if the door is opened and re-closed, the program is ended.

**For models w/o display;**

COMMANDS	Start/Stop	Wash	Rinse	Dry	End	On/Off
Door open	Blink	OFF	OFF	ON	OFF	ON
Door closed	OFF	OFF	OFF	OFF	ON	ON

\*When the door is opened, Dry led is ON together with the blinking Start/Stop led.

When the door is closed, program ends and End led is ON.

- Next, if user presses program or Start/Stop or delay button, machine is in standby position( last executed programme led and Start/Stop led are ON)
- Then, if user presses Start/Stop button, wash led is ON.

**For models w/ display;**

During dry step: if the door is opened and re-closed, the program is continued.

COMMANDS	Wash	Rinse	Dry	End	On/Off	Digit
Door open	OFF	OFF	ON	OFF	ON	Duration of program pauses, 3" program number and 1" duration of program are shown alternately
Door closed	OFF	OFF	ON	OFF	ON	Duration of program resumes

### 3.5 OPENING AND CLOSING DOOR DURING PROGRAM(IN REGENERATION FIRST STEP)

During regeneration and resin washing step: if the door is opened and re-closed, the program continues.

**For models w/o display;**

COMMANDS	Start/Stop	Wash	Rinse	Dry	End	On/Off
Door open	Blink	OFF	OFF	ON	OFF	ON
Door closed	OFF	OFF	OFF	ON	OFF	ON

\*When the door is opened, Dry led is ON together with the blinking Start/Stop led.

When the door is closed, Dry led is ON.

**For models w/ display;**

COMMANDS	Wash	Rinse	Dry	End	On/Off	Digit
Door open	OFF	OFF	ON	OFF	ON	Duration of program pauses, 3" program number and 1" duration of program are shown alternately
Door closed	OFF	OFF	ON	OFF	ON	Duration of program resumes

**3.6 OPENING AND CLOSING DOOR DURING PROGRAM(IN REGENERATION SECOND STEP)**

During regeneration and resin washing step: if the door is opened and re-closed, the program is ended.

**For models w/o display;**

COMMANDS	Start/Stop	Wash	Rinse	Dry	End	On/Off
Door open	Blink	OFF	OFF	ON	OFF	ON
Door closed	OFF	OFF	OFF	OFF	ON	ON

\*When the door is opened, Dry led is ON together with the blinking Start/Stop led.

When the door is closed, the program ends. Machine is in standby position( last executed programme led and Start/Stop led are ON)

**For models w/ display;**

COMMANDS	Wash	Rinse	Dry	End	On/Off	Digit
Door open	OFF	OFF	ON	OFF	ON	Duration of program pauses, 3" program number and 1" duration of

						program are shown alternately
Door closed	OFF	OFF	OFF	ON	ON	"0"

When the door is opened and re-closed, program ends and display shows right aligned "0".

### 3.7 SELECTING AND STARTING PROGRAM WHEN DOOR IS OPENED(BEFORE PROGRAM STARTS)

**For models w/o display;**

COMMANDS	Start/Stop	Wash	Rinse	Dry	End	On/Off
Switch on	ON	OFF	OFF	OFF	OFF	ON
Door open	ON	OFF	OFF	OFF	OFF	ON
Select program	ON	ON/OFF*	ON/OFF*	ON/OFF*	ON/OFF*	ON
Pressure of Start/Stop button	Blink	ON/OFF**	ON/OFF**	ON/OFF**	ON/OFF**	ON
Door closed	OFF	ON	OFF	OFF	OFF	ON

\*If user selects a program when the door is open, related program led(s) is ON.

\*\*Then, if user presses Start/Stop button, Start/Stop led blinks and also related program led(s) is ON.

After closing the door, Wash led is ON and selected program starts.

**For models w/ display;**

COMMANDS	Wash	Rinse	Dry	End	On/Off	Digit
Switch on	OFF	OFF	OFF	OFF	ON	3" program number and 1" duration of default program are shown alternately
Door open	OFF	OFF	OFF	OFF	ON	3" program number and 1" duration of default program are shown alternately
Select program	OFF	OFF	OFF	OFF	ON	3" program number and 1" duration of program are shown alternately
Pressure of Start/Stop button	ON	OFF	OFF	OFF	ON	Duration of program blinks

Door closed	ON	OFF	OFF	OFF	ON	Duration of program
-------------	----	-----	-----	-----	----	---------------------

If user selects a program when the door is open, related program duration and number is seen on the display. Then, if user presses Start/Stop button, duration of the selected program blinks. After closing the door, Wash led is ON and selected program starts.

### 3.8 TERMINATION OF A PROGRAM(END OF PROGRAM)

**For models w/o display;**

COMMANDS	Start/Stop	Wash	Rinse	Dry	End	On/Off
End of program	OFF	OFF	OFF	OFF	ON	ON
Door open	OFF	OFF	OFF	OFF	ON	ON
Door closed	ON	OFF*	OFF*	OFF*	OFF*	ON

\*When the door is closed, related programme, which is last executed, led and Start/stop led are ON. Namely, Machine is in standby position.

**For models w/ display;**

COMMANDS	Wash	Rinse	Dry	End	On/Off	Digit
End of program	OFF	OFF	OFF	ON	ON	"0"
Door open	OFF	OFF	OFF	ON	ON	"0"
Door closed	OFF	OFF	OFF	OFF	ON	3" program number and 1" duration of last executed program are shown alternately

At the end of program, display shows right aligned "0".

If there is no user intervention during 15 minutes after program has ended, machine turns off completely.

### 3.9 CANCELLING OF A PROGRAM(DURING PROGRAM)

**For models w/o display;**

COMMANDS	Start/Stop	Wash	Rinse	Dry	End	On/Off
Pressure of Start/Stop button 3"	OFF	ON/OFF*	ON/OFF*	ON/OFF*	OFF	ON
End of program	OFF	OFF	OFF	OFF	ON**	ON

\*While pressing the Start/Stop button for 3", related washing step led(Wash, Rinse, Dry) is ON.

\*\*During the cancellation process "End led" blinks. After cancelling is finished, "End Led" is ON.

**For models w/ display;**

COMMANDS	Wash	Rinse	Dry	End	On/Off	Digit
Pressure of Start/Stop button 3"	OFF	OFF	OFF	Blink	ON	"1"
End of program	OFF	OFF	OFF	ON	ON	"0"

- Display shows "1" during cancelation process and End led blinks.
- Display shows only one digit "0" that is right aligned at the end of the cancelation process and End led is ON.

### 3.10 IF USER PRESSES ANY BUTTON(AT THE END OF PROGRAM)

#### For models w/o display;

COMMANDS	Start/Stop	Wash	Rinse	Dry	End	On/Off
End of program	OFF	OFF	OFF	OFF	ON	ON
Selection of new program or pressed option	ON	ON/OFF*	ON/OFF*	ON/OFF*	ON/OFF*	ON
Pressure of Start/Stop button	OFF	ON	OFF	OFF	OFF	ON

\*When user selects a program at the end of program, related program led(s) and Start/Stop led are ON. If selected, related option led(s) is ON.

After pressing Start/Stop button, related program led(s) is OFF, Wash led is ON. If selected, related option led(s) is ON.

#### For models w/ display;

COMMANDS	Wash	Rinse	Dry	End	On/Off	Digit
End of program	OFF	OFF	OFF	ON	ON	"0"
Selection of new program or pressed option	OFF	OFF	OFF	OFF	ON	3" new program number and 1" duration of new program are shown alternately
Pressure of Start/Stop button	ON	OFF	OFF	OFF	ON	Duration of new program

When user selects a program at the end of program, related program duration is showed on the display. If selected, related option led is ON.

After pressing Start/Stop button, program starts and Wash led is ON. If selected, related option led(s) is ON.

### 3.11 MODIFICATION OF A PROGRAM WITHOUT RESET

The program continues with the flow program but with the parameters (temperature, times) of the new program. In heating step: If temperature is over than the new desired temperature, cut off heating step and go on with the next step with new parameters.

If temperature is lower than the new desired temperature heat up water to the desired temperature level.

In washing step: If the washing duration is over than the washing duration of new program, cut off washing step and go on with next step of new program.

If the washing duration is lower than the washing duration of new program, go on with washing step.

When new program is selected, display duration is changed to same step of new program.

#### For models w/o display;

COMMANDS	Start/Stop	Wash	Rinse	Dry	End	On/Off
Washing cycle is in progress	OFF	ON/OFF	ON/OFF	ON/OFF	OFF	ON
Pressure of Start/Stop button	Blink	ON/OFF	ON/OFF	ON/OFF	OFF	ON

Select new program	Blink	ON/OFF*	ON/OFF*	ON/OFF*	ON/OFF*	ON
Pressure of Start/Stop button	OFF	ON/OFF**	ON/OFF**	ON/OFF**	OFF	ON

\* If user selects new program, related new program led(s) is ON.

\*\*Program continues with the new parameters and related washing led(s) is ON.

**For models w/ display;**

COMMANDS	Wash	Rinse	Dry	End	On/Off	Digit
Washing cycle is in progress	ON/OFF	ON/OFF	ON/OFF	OFF	ON	Duration of program
Pressure of Start/Stop button	ON/OFF	ON/OFF	ON/OFF	OFF	ON	3" program number and 1" duration of program are shown alternately
Select new program	ON/OFF	ON/OFF	ON/OFF	OFF	ON	3" new program number and 1" duration of new program are shown alternately
Pressure of Start/Stop button	ON/OFF*	ON/OFF*	ON/OFF*	OFF	ON	Duration of new program

\*If user presses Start/Stop button, program continues with the new parameters and related washing led(s) is ON

**3.12 MODIFICATION OF A PROGRAM WITH RESET**

**For models w/o display;**

COMMANDS	Start/Stop	Wash	Rinse	Dry	End	On/Off
Washing cycle is in progress	OFF	ON/OFF	ON/OFF	ON/OFF	OFF	ON
Pressure of Start/Stop button 3"	OFF	ON/OFF	ON/OFF	ON/OFF	OFF	ON
Drain of water	OFF	OFF	OFF	OFF	Blink	ON
End of Drain	OFF	OFF	OFF	OFF	ON*	ON
Select new program	ON	ON/OFF**	ON/OFF**	ON/OFF**	ON/OFF**	ON

\*During the cancellation process End led blinks. After cancelling is finished, "End Led" is ON.

\*\*After the cancellation process, if user selects new program, related program led(s) is ON.

**For models w/ display;**

COMMANDS	Wash	Rinse	Dry	End	On/Off	Digit
Washing cycle is in progress	ON/OFF	ON/OFF	ON/OFF	OFF	ON	Duration of program
Pressure of Start/Stop button 3"	ON/OFF	ON/OFF	ON/OFF	OFF	ON	Duration of program
Drain of water	OFF	OFF	OFF	Blink	ON	"1"
End of Drain	OFF	OFF	OFF	ON	ON	"0"
Select new program	OFF	OFF	OFF	OFF	ON	3" new program number and 1" duration of new program are shown alternately

- Display shows "1" during reset process.
- Display shows only one digit "0" that is right aligned at the end of the reset process

**3.13 SWITCH OFF THE MACHINE DURING PROGRAM AND BEFORE STARTING PROGRAM**

When user presses On/Off button in standby position, machine is changed to Power OFF position and all leds and display are OFF.

**For models w/o display;**

COMMANDS	Start/Stop	Wash	Rinse	Dry	End	On/Off
Before starting program	ON	OFF	OFF	OFF	OFF	ON
Pressure of On/Off button	OFF	OFF	OFF	OFF	OFF	OFF

**For models w/ display;**

COMMANDS	Wash	Rinse	Dry	End	On/Off	Digit
Before starting program	OFF	OFF	OFF	OFF	ON	3" program number and 1" duration of program are shown alternately
Pressure of On/Off button	OFF	OFF	OFF	OFF	OFF	OFF

**3.14 SWITCH OFF THE MACHINE DURING PROGRAM AND AFTER STARTING PROGRAM**

When machine is changed to Power OFF position during program, all leds are OFF, display is OFF, Program is paused and all electrical components are stopped. After pressing On/Off button, machine

is ON. Selecting any program does not affect the program flow of previously selected program. Therefore, previously selected program is resumed.

**For models w/o display;**

COMMANDS	Start/Stop	Wash	Rinse	Dry	End	On/Off
Washing cycle is in progress	OFF	ON/OFF	ON/OFF	ON/OFF	OFF	ON
Machine is "POWER OFF"	OFF	OFF	OFF	OFF	OFF	OFF
Machine is "POWER ON"	OFF	ON/OFF	ON/OFF	ON/OFF	OFF	ON
Select new program*	OFF	ON/OFF	ON/OFF	ON/OFF	OFF	ON
Pressure of Start/Stop button	Blink	ON/OFF	ON/OFF	ON/OFF	OFF	ON
Pressure of Start/Stop button again	OFF	ON/OFF	ON/OFF	ON/OFF	OFF	ON

\*New program cannot be selected without pressing Start/Stop button.

**For models w/ display;**

COMMANDS	Wash	Rinse	Dry	End	On/Off	Digit
Washing cycle is in progress	ON/OFF	ON/OFF	ON/OFF	OFF	ON	Duration of program
Machine is "POWER OFF"	OFF	OFF	OFF	OFF	OFF	OFF
Machine is "POWER ON"	ON/OFF	ON/OFF	ON/OFF	OFF	ON	Duration of program
Select new program*	ON/OFF	ON/OFF	ON/OFF	OFF	ON	Duration of program
Pressure of Start/Stop button	ON/OFF	ON/OFF	ON/OFF	OFF	ON	3" program number and 1" duration of program are shown alternately
Pressure of Start/Stop button again	ON/OFF	ON/OFF	ON/OFF	OFF	ON	Duration of program

\*New program cannot be selected without pressing Start/Stop button.

**Not: Y1X\_W modelleri için kural aşağıdaki gibi olacaktır.**

- Program çalışırken; kapı açılıp tekrar kapandığında veya elektrik gidip tekrar geldiğinde, ürün direk programa kaldığı yerden devam etmez (pause moduna geçsin). müşteri start pause butonuna ekstradan bir kere basar ve program devam eder.

Note: If the washing step is Dry before machine is powered off, program ends after machine is powered on.

**3.15 CANCELLING OF A PROGRAM (DURING DELAY TIME)**

**For models w/o display;**

COMMANDS	Start/Stop	Wash	Rinse	Dry	End	Selected indicators (delay timer)	Related program led	On/Off
Pressure of Start/Stop button for 3"	ON	OFF	OFF	OFF	OFF	ON	ON	ON
End of program	OFF	OFF	OFF	OFF	ON*	OFF	OFF	ON

While pressing the Start/Stop button for 3", selected indicator led(3h, 6h or both 3h and 6h) is ON and related program led is ON.

\*During the cancellation process "End led" blinks. After cancelling is finished, "End Led" is ON.

#### For models w/ display;

COMMANDS	Wash	Rinse	Dry	End	On/Off	Digit
Pressure of Start/Stop button for 3"	OFF	OFF	OFF	OFF	ON	Delay duration
End of program	OFF	OFF	OFF	ON*	ON	"0"

While pressing the Start/Stop button for 3", delay duration is shown on display.

\*During the cancellation process "End Led" blinks and digit shows "1". At the end of cancelling, End led is ON and digit shows right aligned "0".

### 3.16 MODIFICATION OF A PROGRAM DURING DELAY TIME

After selecting new program or same program and pressing Start/Stop button, Delay time resumes, does not start again.

- **For new models; While delay timer is selected but not started or started and paused, if any program button is pressed, delay timer is cancelled and machine goes to ready state. (06.04.2020 tarihinde alınan karar itibarıyla geçerli).**

#### For models w/o display;

COMMANDS	Start/Stop	Selected indicators(delay timer)	On/Off	Related program number led
During delay time	ON	ON	ON	ON
Pressure of Start/Stop button	Blink	ON	ON	ON
Select new program	Blink	ON	ON	New program led(s) is ON
Pressure of Start/Stop button	ON	ON	ON	New program led(s) is ON

New program starts with delay which is selected before.

#### For models w/ display;

COMMANDS	Delay	On/Off	Digit
During delay time	ON	ON	Delay duration
Pressure of Start/Stop button	ON	ON	1" Delay duration, 3" program number and 1" duration of

			program are shown alternately
Select new program	ON	ON	1" Delay duration, 3" new program number and 1" duration of new program are shown alternately
Pressure of Start/Stop button	ON	ON	Delay duration

Note(Y25 & Y26): When user pauses delay duration, 1" delay duration and 3" program number are shown alternately.

### 3.17 SWITCH OFF THE MACHINE DURING DELAY TIME

For all models:

- While delay timer is active, If machine switch off and on by ON/OFF button, delay timer is cancelled and machine goes to ready position.
- If mains power off-on occurs (power cut); delay time resumes, does not start again, at this time Start/Stop led is ON and related delay led blinks twice.

For models w/o display;

COMMANDS	Start/Stop	Selected indicators(delay timer)	On/Off
During delay time	ON	ON	ON
Change machine to "POWER OFF"	OFF	OFF	OFF
Change machine to "POWER ON"	ON	OFF	ON
Select new program	ON	OFF	ON
Pressure of Start/Stop button	OFF	OFF	ON

For models w/ display;

COMMANDS	Delay	On/Off	Digit
During delay time	ON	ON	Delay duration
Mains voltage is cut(Power off)	OFF	OFF	OFF
Mains voltage is back(Power on)	ON	ON	Delay duration blinks twice and then resumes
Select new program	ON	ON	Delay duration
Pressure of Start/Stop button	ON	ON	1" Delay duration, 3" new program number and 1" duration of new program are shown alternately

**Note(Y25 & Y26):** When user starts a programme with delay and activates child lock: if user switch off/on the machine or mains voltage is cut; both delay and child lock is active when machine is energized.

## 4. POWER FAIL

- **During a Delay Start:** At the power on, program consumes the remaining time.
- **During a Drain + Fill step:** At the power on the program restarts the step to the beginning (with the drain).
- **During a Wash step:** At the power on the program consumes the remaining time.
- **During a Heating step:** At the power on the program continues heating up to the desired temperature. The time out for the heating restart to the beginning (water could be cold again).
- **During a Dry step:** At the power on the program ends.
- **During the first two step of a salt regeneration cycle (60" REGVALVE = ON or 60" REGVALVE+DRAIN ON):** At the power on washing program will continue.
- **During the washing resin step at regeneration cycle:** At the power on the program ends.

It is possible that the power fail occurred when a regeneration cycle is requested. If it occurs:

- During the first two step of a salt regeneration cycle ( 60" REGVALVE = ON or 60" REGVALVE+DRAIN ON): at the power on washing program will continue.

- After the first two step of a salt regeneration cycle: at the power on the washing program will end and the resin wash will be performed at the beginning of the next washing cycle.

After a Power Fail washing program re-starts without any delay if temp. is less than 45° C.

After a Power Fail washing program **wait 8"** before re-starts program if temp. is equal or more than 45° C.

### 4.1 STANDBY ON/OFF – POWER ON/OFF

	CL is active in standby position	Delay timer is active	CL+Delay timer are active
Standby Off	Machine turns off	Machine turns off	Machine turns off
Standby On	CL is cancelled	Delay timer is cancelled	CL+Delay timer are active
Power Off	Machine turns off	Machine turns off	Machine turns off
Power On	CL is cancelled	Delay timer is active	CL+Delay timer are active

While washing is being operated, CL(which is activated before) is not cancelled if standby or power off/on is done.

**Note** (for models having buzzer): Opening voice is 3 short beep and closing voice is long beep.

**Note: For USA models** if the power cut occurs and returns back or machine is turned off and on with On/Off button, program / delay timer will be paused.

**Not: USA modellerde** program çalışırken veya erteleme aktifken; şebeke enerjisi gidip gelirse ya da On/Off butonuyla makine kapatılıp açılırsa program / erteleme pause edilir.

## 5. OPTIONS

### 5.1 OPTIONS & MODELS

-In case of Power fail during washing, options are stored in memory.

-When the machine is switched on again, the last selected options are active and washing must go on remaining.

-Due to Eco design requirements, each energized of the machine (by pressing ON/OFF) Eco program must be fixed as default, the options that are chosen before will be cancelled.

- In case of Power fail, options are stored in memory if it occurs in washing cycle.
- For models with display; At the end of the program, when drain step is performed, only the third digit that is on the right of display will be ON. (It shows only one "0"). Then, when the users push any button, display shows the total time of the program).
- For all Y models, each energized of the machine (by pressing ON/OFF), Eco program will be set as default setting. And the options that are chosen before (i.e: child lock, delay option etc...) will be cancelled.

**For models w/o display-w/o diverter;**

Option	Y11	Y12	Y13	Y14	Y15
Delay	X	X	X	X	X
Half load	X	X	X	X	X

**For models w/ display-w/o diverter;**

Option	Y1A	Y1B	Y1C	Y1D	Y1E
Delay	X	X	X	X	X
Half load	X	X	X	X	X
Tablet	X	X	X	X	X
Extra Hygiene	X	X	X	X	X
Extra Rinse	X	X	X	X	X
Extra Dry	X	X	X	X	X
Child Lock	X	X	X	X	X

**For models w/ display-w/ diverter;**

Option	Y21	Y22	Y23	Y24
Delay	X	X	X	X
Half load(3 modes)	X	X	X	X
Tablet	X	X	X	X
Extra Hygiene	X	X	X	X
Extra Rinse	X	X	X	X
Extra Dry	X	X	X	X
Child Lock	X	X	X	X

**For models w/ display-w/ diverter-w/ BLDC – w/ ADO;**

Option	Y25
Delay (1-19h)	X
Half load(3 modes)	X
Tablet	X
Extra Fast	X
Extra Silent	X
Energy Save	X
Child Lock	X

**For models w/ display-w/ diverter-w/ BLDC – w/o ADO;**

Option	Y26
Delay (1-19h)	X
Half load(3 modes)	X
Tablet	X

Extra Fast	X
Extra Silent	X
Extra Drying	X
Child Lock	X

## 5.2 COMPATIBILITY BETWEEN OPTIONS

Options	Delay Timer	Half Load ( 3 modes )	Tablet	Child Lock	Extra Rinse	Extra Hygiene	Extra Dry
Delay Timer		OK	OK	OK	OK	OK	OK
Half Load ( 3 modes )	OK		OK	OK	OK	OK	OK
Tablet	OK	OK		OK	OK	OK	OK
Child Lock	OK	OK	OK		OK	OK	OK
Extra Rinse	OK	OK	OK	OK		OK	OK
Extra Hygiene	OK	OK	OK	OK	OK		-
Extra Dry	OK	OK	OK	OK	OK	-	

For Y25 & Y26:

Options	Delay Start	Half Load ( 3 modes )	Tablet	Child Lock	Energy save(Extra Drying for Y26)	Extra Fast	Extra Silent
Delay Start		OK	OK	OK	OK	OK	OK
Half Load ( 3 modes )	OK		OK	OK	OK	OK	OK
Tablet	OK	OK		OK	OK	OK	OK
Child Lock	OK	OK	OK		OK	OK	OK
Energy save(Extra Drying for Y26)	OK	OK	OK	OK		OK	OK
Extra Fast	OK	OK	OK	OK	OK		-
Extra Silent	OK	OK	OK	OK	OK	-	

## 5.3 COMPATIBILITY BETWEEN OPTIONS & PROGRAMS

	OPTIONS	Delay	Half Load	Tablet	Child Lock	Extra Hygiene	Extra Rinse	Extra Dry
<b>PROGRAMS</b>								
Prewash		X	X*	-	X	-	-	-
Quick 30'		X	X*	X	X	-	X	X
Eco 50°C		X	X	X	X	X	X	X
Super 50'		X	X	X	X	X	X	X
Delicate 40°C		X	X	X	X	X	X	X

Intensive 65°C		X	X	X	X	X	X	X
Daily 60		X	X	X	X	X	X	X
Normal 55°C		X	X	X	X	X	X	X
Auto Delicate 30-50°C		X	X	X	X	X	X	X
Auto Normal 50-60°C		X	X	X	X	X	X	X
Auto Intensive 60°-70°C		X	X	X	X	X	X	X
Steamwash		X	X	X	X	X	X	X

*\*Half load option(with Prewash/Quick 30' program) cannot be selected for models without diverter.*

**For Y25:**

	OPTIONS	Delay Start	Half Load (3 modes)	Tablet	Child Lock	Energy Save	Extra Fast	Extra Silent
PROGRAMS								
Prewash		X	X	-	X	-	-	-
Jetwash 14'		X	X	-	X	X	-	-
Quick 30'		X	X	X	X	X	-	-
Eco		X	X	X	X	X	X	X
Dual Pro wash		X	X	X	X	X	X	X
Super 50'		X	X	X	X	X	-	-
Hygiene 70 C		X	X	X	X	X	-	-
Auto intensive 60-70 C		X	X	X	X	X	-	-
Steam Wash		X	X	X	X	-	-	-

**For Y26:**

	OPTIONS	Delay Start	Half Load (3 modes)	Tablet	Child Lock	Extra Drying	Extra Fast	Extra Silent
PROGRAMS								
Prewash		X	X	-	X	-	-	-
Jetwash 14'		X	X	-	X	-	-	-

Quick 30'		X	X	X	X	X	-	-
Eco		X	X	X	X	X	X	X
Dual Pro wash		X	X	X	X	X	X	X
Super 50'		X	X	X	X	X	-	-
Hygiene 70 C		X	X	X	X	X	-	-
Auto intensive 60-70 C		X	X	X	X	X	-	-
Steam Wash		X	X	X	X	X	-	-

For YA7\_USA / YB7\_USA:

YB7_USA	Programların OPSİYON uyumu						
	delay	Child Lock	½ HL	Sanitize	H.Temp	Ext Dry	Ext Rinse
Regular	X	X	X	X	X	X	X
Auto / REGULAR	X	X	X	X	X	X	X
Intensive +	X	X	X	X	X	X	X
Intensive	X	X	X	X	X	X	X
Daily	X	X	X	X	X	X	X
Delicate	X	X	X	-	-	X	X
Super 50'	X	X	X	X	X	X	X
Rinse	X	X	X	-	-	-	-

#### 5.4 OPTION DEFINITION

Option	Short description
Delay Timer	Program starts with a delay
Half Load(3 modes)	The wash is executed with upper spray, lower spray or both in half load mode.
Tablet	Change of washing temperature and time
Child Lock	It can be activated by pressing related buttons at the same time for 3 seconds(see 5.4.4) Buttons are blocked to press.
Extra Hygiene	Increase the washing temperature at final rinse step in order to eliminate bacteria
Extra Dry	This option increases water temperature at final rinse step and increase drying step duration up to 10 min.
Extra Rinse	Extra rinse option adds an extra rinse step to achieve more hygienic washing. Programme duration is increased between min. %4 and max. %16 according to washing programme
Energy Save	At the end of the drying process, the dishwasher door automatically opens to allow steam to escape and cool air to circulate.

Extra Fast	Reduces the duration of the washing
Extra Silent	Reduces the sound pressure level of the washing

#### 5.4.1 Delay Timer

The delay timer option is selected by pressing the regarding option button before the program starts. It is possible to select the delay before selecting the program.

Before program is started, all indicator leds and delay led are OFF.

##### For models w/o display:

When delay button is pushed first,

- 6h led is OFF, and 3h led is ON. (It means program starting is delayed 3 hours)

When delay button is pushed second,

- 3h led is OFF, 6h led is ON. (It means program starting is delayed 6 hours)

When delay button is pushed third,

- 3h and 6h leds are ON. (It means program starting is delayed 9 hours)

When delay button is pushed fourth,

- 3h and 6h leds are OFF. (It means delay process is cancelled)

If user presses Start/Stop button when a delay time is selected, the program with delay will be in operation. Start/Stop led is ON.

##### For models w/ display:

Before starting the program,

- Delay is selected by consecutive pressures of the button. Delay led is ON.
- At each pressure, the display shows one step of increment (from 1h to 19h); having been reaching its maximum value (19h)
- The next pressure clears the delay and shows "0h".
- Before pressing Start/Stop button, selected program and delay durations are shown on the display alternately in 2" interval.  
Note(Y25 & Y26): Program number and delay duration are shown alternately.
- After pressing Start/Stop button, Delay led blinks once, delay duration is shown on the display and the program with delay will be in operation.

Cancelling the delay start is possible during the delay time.

- Press the delay button, until the delay time is "0h"
- Press Start/Start button and the washing program will start.

-Erteme zamanının ortasında / içinde erteme süresini değiştirmeden ops ekleme çıkarma yapıldığında erteleme süresi kaldığı yerden devam etmektedir. Fakat Erteleme süresi değişirse yeni seçilen erteleme zamanı baştan başlar. Eğer erteleme seçilip başlatılmadan ya da başlatılıp durdurulduktan sonra herhangi bir program tuşuna basılırsa erteleme iptal olur, makine seçilen programda hazır konuma geçer.

- **When delay timer is selected, if machine switch off and on by ON/OFF button, delay timer is cancelled and machine goes to ready state.**
- **If mains power off-on occurs (power cut); delay time resumes, does not start again.**
- **When delay timer is selected but not started or started and paused, if any program button is pressed, delay timer is cancelled and machine goes to ready state. (06.04.2020 tarihinde alınan karar itibarıyla geçerli).**

**NOT: SADECE USA Amerika Modeller - Delay iptal (cancel delay 3 sec.) Adı altında bir serigrafî olacak. Mesela delay 6h de iken bunu iptal etmek için ya 19h a kadar gidecek ya da "DELAY / cancel delay 3 sec." tuşuna 1.8 sn. basıp 6h yazısını ortadan kaldıracak. Herhangi bir program iptali veya drain durumu söz konusu değil.**

#### **5.4.2 Half Load**

**For models w/o display;**

Half load is enabled/disabled by pressing "Delay" button for 1,8". Delay led is ON.

**For models w/ display-w/o diverter;**

Half load is enabled/ disabled by pressing "Options" button once and Half load led is ON.

**For models w/ display-w/ diverter;**

If neither half load option is selected before, "Upper Basket" and "Lower Basket" leds are OFF. Half Load option is selected before program start by pressing "Half Load" button.

When a half load option is chosen, washing program starts from main wash step (skipping the prewash step)

When Half Load button is pressed:

**First time:** Upper Basket led is ON and Lower Basket led is OFF. Wash is executed only with upper spray arm.

**Second time:** Upper Basket led is OFF and Lower Basket led is ON. Wash is executed only with lower spray arm.

**Third time:** Upper Basket and Lower Basket leds are ON. Half load Wash is executed with both arms.

**Fourth time:** Upper Basket and Lower Basket leds are OFF. Normal wash is executed.

#### **5.4.3 Tablet (for models with display)**

Tablet option is selectable at any time. If it is pressed during a washing program the program will execute the following steps with "tablet" functions instead of the normal.

**For models w/o diverter;**

Tablet option is selected by pressing "Options" button twice. Tablet led is ON.

**For models w/ diverter;**

Tablet option is selected by pressing "Half Load" button for 1,8". Half Load led is ON.

When user selects tablet option, main wash temperature is determined according to tablet temperature under no circumstances. Even if another option or automatic program is run together with the tablet option.

Temperature value of tablet option is determined according to dissolution temperature of tablet detergent .

#### **5.4.4 Child Lock**

Child Lock Activation Button Combination:

For models w/ display-w/o diverter;

Child lock is enable/disabled by simultaneously pressure of "Extra" and "Options" buttons for 3".

For models w/ display-w/ diverter;

Child lock is enable/disabled by simultaneously pressure of "Extra" and "Half Load" buttons for 3".

When lock is enabled, all leds blink and Display shows "CL" once

When lock is disabled, all leds blink and Display shows “CL” twice

When lock is enabled and a button is touched, all leds blink and Display shows “CL” once

**Valid from 11.01.2021;** in any mode (ready, run, pause, end, delay start), while the child lock is active,

- if the machine turns off and on again by on/off button, the child lock will stay active when the machine is energized. It will not be cancelled.
- if the mains power (220 V) is cut and machine is energized again, the child lock will be cancelled. (For the first phase of Vel sw's this behaviour is same with on/off button, this will be implemented on the 2<sup>nd</sup> phase)
- If the machine is turned off automatically 15 minutes after any usage, the child lock will stay active when the machine is energized.
- If the power cut occurs after machine is turned off by on/off button, the child lock will stay active when the machine is energized.

**11.01.2021'den itibaren geçerli olacak şekilde;** herhangi bir modda CL aktifken;

- makine on/off butonu ile kapatıp açıldığında CL devam edecek.
- makinenin şebeke enerji kesilip verildiğinde CL iptal olacak. (Vel yazılımlarında ilk fazda bu davranış on/off butonu ile yapıldığı gibi CL devam ediyor şeklinde alındı. Şebekedeki davranış farklılaştırması 2. faz olarak çalışılacak.)
- makine 15 dakika sonra otomatik kapandığında çocuk kilidi aktif olarak gelir.
- Makine on/off ile kapatıldıktan sonra şebeke enerjisi kesilirse, makine tekrar enerjilendirildiğinde çocuk kilidi aktif olarak gelir.

#### 5.4.5 Extra Options (for models w/ display)

Extra option is selected before program start by pressing “Extra” button and regarding led is ON.

When Extra button is pressed;

**First time:** Hygiene led is ON, Rinse and Dry leds are OFF. Wash is executed with the following steps with “Hygiene” functions instead of the normal.

**Second time:** Rinse led is ON, Hygiene and Dry leds are OFF. Wash is executed with the following steps with “Rinse” functions instead of the normal.

**Third time:** Dry led is ON, Hygiene and Rinse leds are OFF. Wash is executed with the following steps with “Dry” functions instead of the normal.

**Fourth time:** Hygiene and Rinse leds are ON, Dry led is OFF. Wash is executed with the following steps with both “Hygiene” and “Rinse” functions instead of the normal.

**Fifth time:** Rinse and Dry leds are ON, Hygiene led is OFF. Wash is executed with the following steps with both “Rinse” and “Dry” functions instead of the normal.

**Last time:** Hygiene, Rinse and Dry leds are OFF. Normal wash is executed.

Note: Hygiene and Dry options cannot be selected together. Hence, Hygiene+Dry+Rinse cannot be selected also.

#### 5.4.6 Extra Options (for Y25 & Y26)

Extra option is selected before program start by pressing “Extra” button and regarding led is ON.

When Extra button is pressed;

**First time:** Energy save(Drying for Y26) led is ON, Fast and Silent leds are OFF. Wash is executed with the following steps with “Energy save” functions instead of the normal.

**Second time:**Fast led is ON, Energy save(Drying for Y26)and Silent leds are OFF. Wash is executed with the following steps with “Fast” functions instead of the normal.

**Third time:** Silent led is ON, Energy save(Drying for Y26)and Fast leds are OFF. Wash is executed with the following steps with “Silent” functions instead of the normal.

**Fourth time:** Energy save(Drying for Y26)and Fast leds are ON, Silent led is OFF. Wash is executed with the following steps with both “Energy Save” and “Fast” functions instead of the normal.

**Fifth time:** Energy save(Drying for Y26)and Silent leds are ON, Fast led is OFF. Wash is executed with the following steps with both “Energy save” and “Silent” functions instead of the normal.

**Last time:** Energy save(Drying for Y26), Fast and Silent leds are OFF. Normal wash is executed.

Note: Fast and Silent options cannot be selected together. Hence, Energy save + Fast + Silent cannot be selected also.

## 6. SOFTWARE REQUIREMENTS

### 6.1 HEATER

Heating relay must be switched with un-supplied Heater.

- Stop Circulation Pump.
- Wait for pressure switch certainly open.
- Open/Close Heater Relay
- Wait (Heater relay certainly close);
- Start Circulation Pump.

If Tablet is selected, heating steps must be < 55°C for steps before last rinse.

### 6.2 WATER FILL

Water Load is obtained by flow meter signals. When a fixed quantity of water is loaded, the reaching water level is checked by the activation of circulation pump. When the pressure is high enough, the pressure switch is activated.

*For 1L water inlet, MCU must detect **210 Pulse/L** (with +5% tolerance) from flowmeter .*

At the start program a drain 30” + empty is executed before fill.

When Inlet valve is ON, if there aren’t flow meter impulses, failure routine of “absence of flow meter impulses routine” works (see on failure chapter).

If pressure sensing switch turns OFF during the wash, after a drain +20”, another water load is executed (also see”return empty level” failure in failure chapter).

Water fill must work;

- Pressure > 0,8l: all OK
- 0,3<pressure<0,8l:OKwith time out
- Pressure< 0,3l: stop cycle.

Water fill is performed spray arms start.

*Note:*

Y1: upper spray arm and lower spray arm start together.

Y2: lower spray arm starts.

### 6.3 WATER DRAIN

Water drain starts with drain pump ON for 33". After 30", circulation pump ON. When empty level is recognized (by pressure switch signal), the circulation pump stops and the machine continues for the request steps.

If pressure switch level doesn't switch in Empty level (during circulation pump on), failure of Water drain works (see 8.failure routines).

Water drain is performed with lower spray arm

*Note:*

Y1: drain is performed with upper and lower spray arms.

Y2: drain is performed with lower spray arm.

#### **Detergent dispenser step**

After wash+heating step is started 3 seconds, Dispenser is activated during 5 seconds. If power fail or opening door or pushing Start/Stop or switching OFF is happened, Detergent dispenser step is started again.

Y2: for the detergent step 2' of upper spray arm are performed.

#### **Rinse aid dispenser step**

Dispenser is activated 25 seconds during rinse aid dispenser step twice. There is 5 seconds between two activation. If power fail or opening door or pushing Start/Stop or switching OFF is happened, Dispenser is activated one more time 25 seconds

If the door is opened and re-closed during washing program, without a re-start program, detergent dispenser must return in Rinse aid distribution state.

Y2: for the rinse aid step 2' of upper spray arm is performed.

### **6.4 REGENERATION CYCLE**

When it occurs the regeneration valve works after last rinse and during the drying steps. There are 6 hardness levels.

<b>Water Hardness level</b>	<b>Litres</b>
Level 1	Never
Level 2	116 lt
Level 3	64 lt
Level 4	52 lt
Level 5	46 lt
Level 6	16 lt

The consumed liters are counted by flow meter impulses.

In case of flow meter broken, the liters corresponding at the flow meter time out are used

If user cancels a program during regeneration or after regeneration and before resin wash, at the beginning of the next program the dishwasher performs the resin wash to remove the salty water from

the resin chamber. The resin wash will be: load 2 lt of water with drain pump on. During the resin wash the circulation Pump must be off.

Regeneration is not performed at prewash program

If water hardness level is changed from lower to higher, regeneration cycle is performed at the end of the first program

If water hardness level is changed from higher to lower, regeneration cycle is not performed at the end of the first program. Regeneration is performed after water level reach to value of level

- If Water hardness level is 5 or 6
  - First regeneration step is performed 0,2lt water
- If Water hardness level is 2 or 3 or 4
  - First regeneration step is performed 0,1lt water
- If Water hardness level is 1
  - Regeneration step is not performed

-The consumed liters are counted by FLM(flow meter) impulses.

-In case of FLM broken, the liters corresponding at the FLM time out are used. (2,1 lt + 2,5 lt ).

-In case of "Tablet" option is ON ;

- \*If the level set is less than L4: the regeneration cycle is not performed, but the quantity of consumed water is counted. When the target value is reached, at the first cycle without the "Tablet" ,the regeneration cycle is performed.
- \*If the level set is equal or more than L5: the regeneration cycle is performed when the quantity target is reached.

-If the washing program is a "prewash program", the regeneration cycle is not performed.

-If user cancels a program during regeneration or after regeneration and before resin wash, at the beginning of the next program the dishwasher performs the resin wash to remove the salty water from the resin chamber. The resin wash will be: load 2 lt of water with drain pump on.

-During the resin wash, the circulation Pump must be OFF.

-If the level of regeneration step is incremented, (for ex:from level3 to level 6) ,at the end of the next washing cycle, it must perform resin wash.

-If the regeneration level is decremented, (for ex: from level4 to level 3); checked how much water used until then and according to new level, how much water will be used more for resin wash is calculated.(level 3=64 lt- used liters until then).

-During waiting step of regeneration process, end user open/close the door or Power OFF /ON condition, program goes to END, but next step of washing cycle starts with resin wash, so that water level resets to zero and re-counts down from corresponding water level.

- When there is no flowmeter connection (by removing flowmeter cable), Electronic card saves the water as 4,58 lt per step.

-If there occurs regeneration step after the programs without drying step or programs having less than 15min drying step, at the end of the program (before reg cycle) the duration must be corrected from 0:01 to 0:15 and recount down during reg step.

## 6.5 FEATURE OF TIME PHASE

- At the beginning of the main wash of eco program, If temperature of water < 30C , Time phase is not activated at the main wash of eco program
- At the beginning of the main wash of eco program, If temperature of water > 30C , Time phase is activated at the main wash of eco program
- These two rules cover only eco programs.

## 6.6 VOLTAGE SENSING CONTROL

When main supply voltage is below 145VAC, voltage sensing circuit detect low voltage and program is stopped by software.

Take memory failure code of low voltage to show at the beginning of service test.

After main supply voltage is above 155VAC, program is started again

When main supply voltage is above 285VAC, voltage sensing circuit detect high voltage and program is stopped by software.

Take memory failure code of high voltage to show at the beginning of service test.

After main supply voltage is below 275VAC, program is started again

- If voltage is low or high during 3 hours or more, at the end of the 3 hours:
  - Program go to failure routine without draining, Failure code of low voltage is shown to user
  - Program go to failure routine without draining , Failure code of high voltage is shown to user

**For USA models:** Low voltage detection is not available, only high voltage is detected as follow.

When main supply voltage is above 145VAC, voltage sensing circuit detect high voltage and program is stopped by software.

Take memory failure code of high voltage to show at the beginning of service test.

After main supply voltage is below 135VAC, program is started again

- If voltage is low or high during 3 hours or more, at the end of the 3 hours:
  - Program go to failure routine without draining, Failure code of low voltage is shown to user
  - Program go to failure routine without draining , Failure code of high voltage is shown to user

## 6.7 NTC VALUES

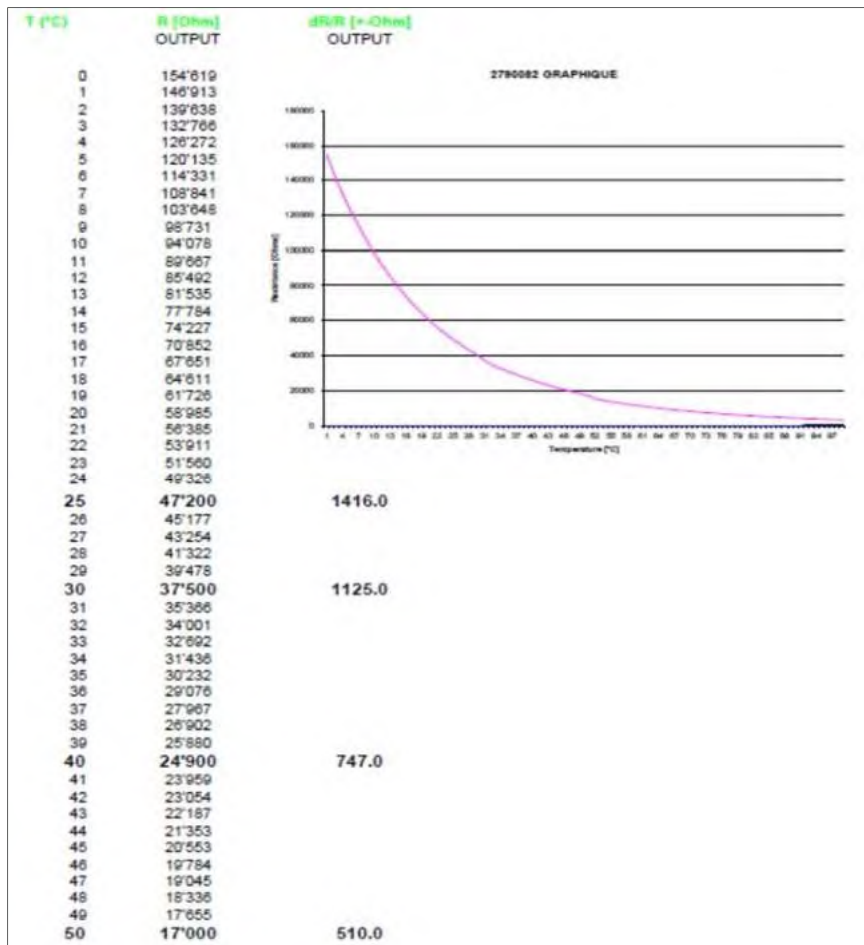

T (°C)	R (Ohm)	dR/R (+-%)
51	16'371	
52	15'766	
53	15'185	
54	14'626	
55	14'090	
56	13'573	
57	13'077	
58	12'600	
59	12'141	
<b>60</b>	<b>11'700</b>	<b>351.0</b>
61	11'295	
62	10'905	
63	10'531	
64	10'171	
65	9'824	
66	9'491	
67	9'171	
68	8'862	
69	8'566	
<b>70</b>	<b>8'280</b>	<b>248.0</b>
71	8'005	
72	7'740	
73	7'485	
74	7'240	
75	7'004	
76	6'776	
77	6'557	
78	6'345	
79	6'141	
<b>80</b>	<b>5'945</b>	<b>178.0</b>
81	5'756	
82	5'573	
83	5'397	
84	5'227	
85	5'064	
86	4'906	
87	4'753	
88	4'606	
89	4'464	
90	4'327	
91	4'195	
92	4'067	
93	3'944	
94	3'825	
95	3'709	
96	3'598	
97	3'491	
98	3'387	
99	3'287	
100	3'190	

## 6.8 WATER HARDNESS SET

Only service can execute this procedure. This procedure erases the cycle counter. For AU Y models, water hardness level is level 1 as default.

### For models w/o display;

#### Button combination for Water hardness setting:

- Power OFF; press program button.
- Power ON and continue to press program button at least for 3".
- If "Hardness set" is recognized all leds blink for 2".
- Release program button. The last setting level is viewed\*.

Level	Wash	Rinse	Dry	End
1	FIX	OFF	OFF	OFF
2	OFF	FIX	OFF	OFF
3	OFF	OFF	FIX	OFF
4	OFF	OFF	OFF	FIX
5	FIX	OFF	OFF	FIX
6	OFF	FIX	OFF	FIX

→ Press program button to set the desired level.  
 At any pressure of program button hardness level is incremented. Hardness level 1 returns after hardness level 6.

\* If it is the first hardness set, hardness level is level 3.

**For models w/ display;**

- Power OFF; press program button.
- Power ON and continue to press program button at least for 3".
- If "Hardness set" is recognized "SL" is shown for 2".
- Release program button. The last setting level is viewed\*.
- Press program button to set the desired level.

Level	Display
1	L1
2	L2
3	L3
4	L4
5	L5
6	L6

At any pressure of program button hardness level is incremented. Hardness level 1 returns after hardness level 6.

\* If it is the first hardness set, hardness level is L3.

\*\*Default hardness level for USA models is L1.

**6.9 RINSE AID SET**

In order to enter rinse aid set, user applies below steps.

- Power OFF; press program button.
- Power ON and continue to press program button at least for 5".
- If "Rinse aid set" is recognized;
  - all leds blink twice if model is without display.
  - If model has display, "rA" is shown.
- Release program button. The last setting level is viewed\*.
- Press program button to set the desired level.

At any pressure of program button rinse aid level is incremented. The level 1 returns after level 5.

For models without display; rinse aid levels are the same with water hardness levels as shown in the table.

Level	Wash	Rinse	Dry	End
1(0cc)	FIX	OFF	OFF	OFF
2(1,5cc)	OFF	FIX	OFF	OFF
3(3cc)	OFF	OFF	FIX	OFF
4(4,5cc)	OFF	OFF	OFF	FIX
5(6cc)	FIX	OFF	OFF	FIX

For models with display;

Level	Display
1(0cc)	r1
2(1,5cc)	r2
3(3cc)	r3
4(4,5cc)	r4
5(6cc)	r5

\* If it is the first rinse aid set, Default rinse aid level is 4 which corresponds to 4,5 cc.

If the rinse aid tank is empty and user sets rinse aid level as 1(0cc), "lack of rinse aid" warning is not shown.

Sliding dispenser dosages are shown below in detail.

- 1 rinse aid dosage is performed when dispenser is ON during 8" and OFF during 8". =>1,5cc  
 2 rinse aid dosages are performed 8" ON-8" OFF-8" ON-8" OFF=>3cc  
 3 rinse aid dosages are performed 8" ON-8" OFF-8" ON-8" OFF-8" ON-8" OFF=>4,5cc  
 4 rinse aid dosages are performed 8" ON-8" OFF-8" ON-8" OFF-8" ON-8" OFF-8" ON-8" OFF =>6cc

<i>Action</i>		<i>Old</i>		<i>New(Sliding dispenser)</i>	
Detergent cover opening:		5"		0.3"	
Rinse aid dose:	Dose setting:	Manual in the dispenser		Automatic in the software	
	Dose quantity and time to delivery	1 - 1cc	25"ON; 2"OFF; 25"ON For each setting from 1 to 6	1 - 0cc	OFF
		2 - 2cc		2 - 1.5cc	8"ON; 8"OFF
		3 - 3cc		3 - 3cc	8"ON; 8"OFF
		4 - 4cc		4 - 4.5cc	8"ON; 8"OFF
		5 - 5cc		5 - 6cc	8"ON; OFF
		6 - 6cc		n/a	n/a
	Standard dose of rinse aid setting by manufacturer	3 (set by manually)		(4-4,5cc set by software)	

### 6.10 IONIZER(All models)

Ionizer function can be activated/deactivated with specified button combinations. Also, when machine is turned off and then on, ionizer function is cancelled.

Ionizer cycle is as follow: 5' ON, 55' OFF, 5' ON,55' OFF,.. After 24 hours is completed, ionizer function is deactivated automatically by software.

During 5' ON; ionizer component , mini fan and turbo fan work together. During 55", they do not work.

Ionizer must not work within a program.

When the door is opened, ionizer+mini fan+turbo fan stops. They do not work.

Ion led and inner light are on when the door is opened. Ion led lights up like dimming.

**Not: Modelde İON ve UVON var ise; Ion devreye alınıp kapı kapatıldığında ionizer mini fanı çalışmaktadır. İyonizer mini fan ile UVON led bağlantısı donanımsal olarak ortak olduğu için ikisi birlikte çalışmaktadır, ion sırasında uvon ledi de donanımsal yanmaktadır.**

#### For models w/o display;

Button combinations for ION Setting: Press program button for 3". When ionizer function is activated, Rinse and Dry leds are ON.



**For models w/ display;**

Press Extra button for 3". Display shows "Ion" when ionizer function is activated.

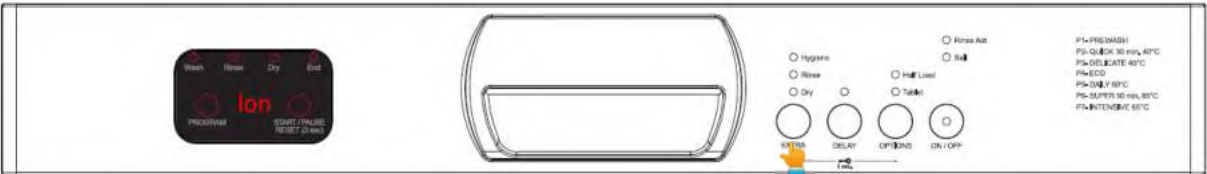
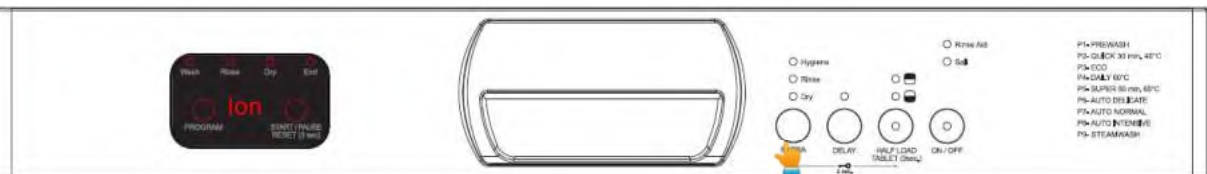

Figure for Y2# is as below.



UVON TECT

**6.11 DEFAULT TURBIDITY**

All 45&60cm Y1 and Y21-Y22-Y23 models with sliding dispenser have default turbidity function. Thanks to this, auto program works when turbidity is connected. Intensive program works when turbidity is not connected.

Models with turbidity contains FA error, the others does not.

**6.12 INNER LIGHT (45&60 cm Y1-Y2 models, USA models)**

Machine must be ON position during activation and deactivation of inner light modes. Open or close position of the door is not important.



Button combinations to control Eco mode/Inner Light:

How to change from "ECO MODE" to "NORMAL MODE" for Inner Light option

First energize the machine via On/Off button. (if it is in OFF position).  
 For Y2x: Press "extra" and "delay" buttons simultaneously for 3 seconds.  
 "ILO" will be shown in the display (top and front) for 2 seconds to show the "Normal Mode" is selected for inner light option.

After "Normal Mode" is selected, the inner light will be ON as long as the machine is energized and machine door is open.

How to change from "NORMAL MODE" to "ECO MODE" for Inner Light option

First energize the machine via On/Off button. (if it is in OFF position).

For Y2x: Press "extra" and "delay" buttons simultaneously for 3 seconds.

"IL: 01" will be shown in the digit display for 2 seconds to show the "Eco Mode" is selected for inner light option.

Also inner light turns OFF and ON again (blinks momentarily) to show this selection is activated.

After "Eco Mode" is selected, the inner light will be ON for 4min after machine door is opened and then turns OFF.

If any user intervention occurs such as pressing buttons, Eco Mode cycle starts from beginning (inner light is ON for 4min and then becomes OFF again)

Factory setting for inner light is set to "IL: 01".

While implementing Ionizer function for April 2018, we added 12V DC inner light for Y1 series.

Y1 w/o display: Press Program+Delay for 3" to activate Eco/Normal mode.

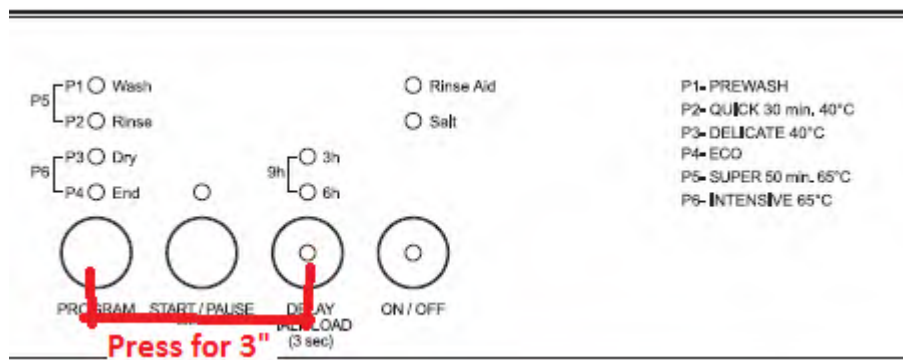

-Normal mode: P1 and P2 leds will be ON for 2 seconds to show the "Normal Mode" is selected for inner light option. Then machine returns showing the last selected program.

-Eco mode: P1,P2 and P3 leds will be ON for 2 seconds to show that the "Eco Mode" is selected for inner light option. Also inner light turns OFF and ON again (blinks momentarily) to show that this selection is activated. Then machine returns showing the last selected program.

Y1 w/ display, Y USA models: Press Extra+Delay for 3" to activate Eco/Normal mode.

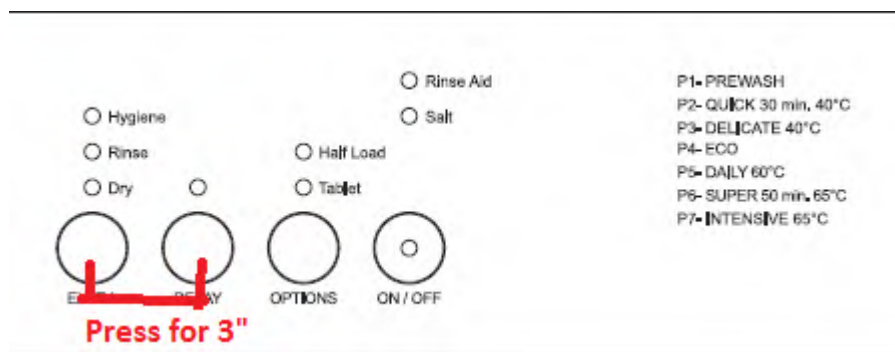

### 6.13 AUTOMATIC PROGRAM(TURBIDITY SENSOR)

Turbidity sensor is performed in the “auto delicate”, “auto normal” and “auto intensive” programs.

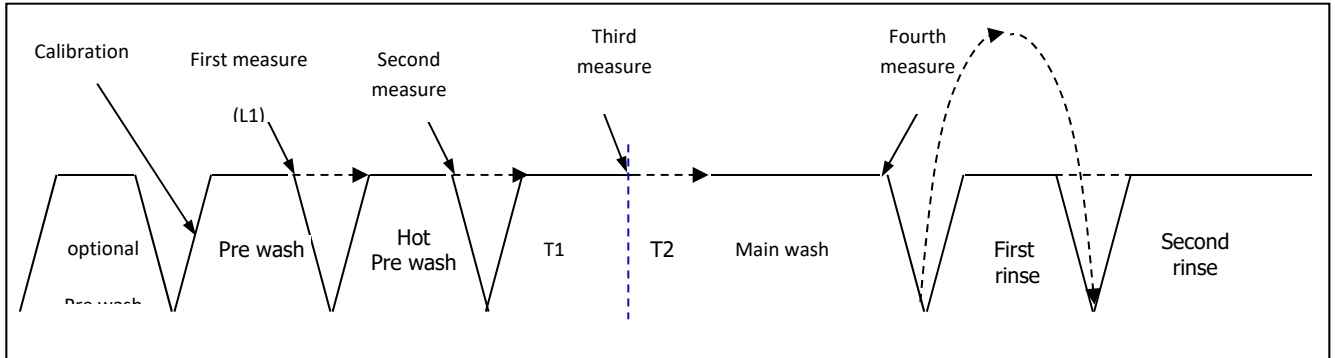

- 1) The calibration is executed after reaching P1 level in the first filling step.
- 2) The first measure is executed at the end of pre-wash.
  - If turbidity is  $\leq$  TURBIDITY-LEVEL 1: drain is skipped.
  - If turbidity is  $>$  TURBIDITY-LEVEL 1: drain is skipped.
- 3) The second measure is executed at the end of hot pre-wash.
  - If turbidity is  $\leq$  TURBIDITY-LEVEL 2: Drain is skipped.
  - If turbidity is  $>$  TURBIDITY-LEVEL 2: Drain is skipped.
- 3) The third measure is executed after the first heating step in the main wash.
  - If turbidity is  $\leq$  TURBIDITY-LEVEL 3: The second heating step is skipped
  - If turbidity is  $>$  TURBIDITY-LEVEL 3: The second heating step is performed (T24\_7 is performed)
- 4) The fourth measure is executed at the beginning of rinses.
  - If turbidity is  $\leq$  TURBIDITY-LEVEL 4: First rinse is skipped.
  - If turbidity is  $>$  TURBIDITY-LEVEL 4: First rinse is executed.

The levels :

TURBIDITY-LEVEL 1 = 3,0V

TURBIDITY-LEVEL 2 = 3,4V

TURBIDITY-LEVEL 3 = 3,7V

TURBIDITY-LEVEL 4 = 3,8V

In case of break of turbidity sensor, the Automatic cycle is entirely executed. The fault is not reported.

For Eco program having turbidity check(Turb L1 after main wash heating)

Wash map becomes as below. Also, Circulation pump works at 3100 rpm during the turbidity check of Eco.

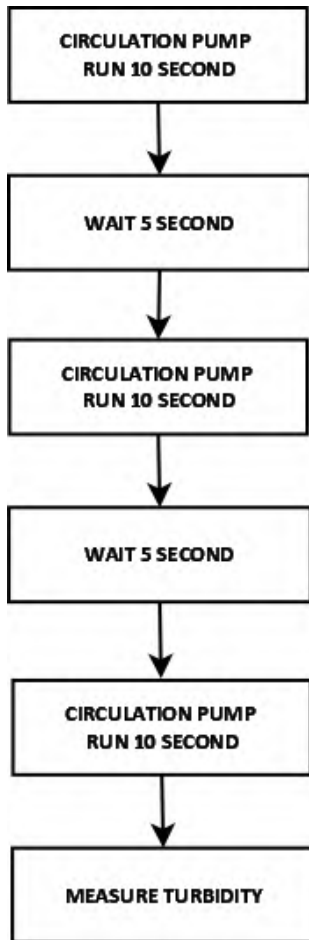

#### 6.14 AUTODOOR OPEN SYTEM

Energy save option is not selectable at any time. During program, energy save option cannot be cancelled or cannot be added. If user presses energy save button during program, the buzzer gives a long sound that is activated to warn that this is not a valid command.

Button combination for Energy Save Option:

Energy save option is enable by firstly pressure of Extra button (Energy save led lights up) before starting the program.

Energy save option is disabled by pressing Extra button until Energy save led turns off.

- When option is selected, The door is opened by the Door Open System at the end of washing program.
- Program in the 1 (Last 1 minute before program finishing)
  - Start to count 2 minutes in the memory
  - TY4 triac is driven by microcontroller and door open system is energized
  - The buzzer gives sound (1"ON + 4"OFF) until auto door mechanism open the door
  - There is 1 on the dislay during this time.
- When Auto door mechanism open the door
  - TY4 triac is not driven by microcontroller
  - There is 0 on the display.
  - Stop to count 2 minutes in the memory
- If Auto door is not opened in 2 minutes

- TY4 triac is not driven by microcontroller
- There is 0 on the display.
- FC failure code is saved to memory

Machine must be ON position during activation and deactivation of door open system. Position of the door (open/close) is not important to activate/deactivate the system. But during washing cycle, it is not enabled to activate /deactivate to this feature.

- How the system works:
  - The unlocked door goes down.
  - TY4 triac are used to control of auto door mechanism.
  - The mechanism stops the door at 10 cm opening.
- Benefits:
  - At hot rinse step, the water is heated up to reasonable values and A class drying is provided by letting the steam flow away to air from the dishwasher.
  - Some of required heating energy for drying is saved at hot rinse step.

Factory setting for auto door open system is set to "OFF" except Eco program

Factory setting for Eco program is set to "ON".

Auto door option button is illuminated (ON) when user selects at only Eco program by each pressing program selection button.

In Eco program, Auto door must be opened in every cycle until the end user unselect the Energy save option for Eco program. That is to say, In first cycle of Eco or other cycles, Auto door system must be performed (ON) until end user deactivate Auto door system.

Due to Eco design requirements, each energized of the machine (by pressing ON/OFF) Eco program must be fixed as default, energy save option led must be ON(only valid for Eco) and the options that are chosen before will be cancelled.

For ex: when user power OFF/ON→ Eco program is fixed as default, energy save option led is ON.

Then if user press again program button, in this case machine passes to Dual pro wash, but energy save option led must become OFF.

### 6.15 AUTODOOR CONTROL TEST(Y25)

Autodoor Test Button Combination: Press "Extra" button. Switch-on the dishwasher. Keep pressing Extra button for 3"

After 3", display shows "dc" (means that Door control) characters during 2 sec, then "1" characters appear.



- Program in the "1" (Last 1 minute before program finishing)
  - Start to count 2 minutes in the memory
  - TY4 triac is driven by microcontroller and door open system is energized
  - The buzzer gives sound (1"ON + 4"OFF) until auto door mechanism open the door
    - There is 1 on the display during this time.
- When Auto door mechanism open the door

- TY4 triac is not driven by microcontroller
- There is 0 on the display.
- Stop to count 2 minutes in the memory
- If Auto door is not opened in 2 minutes
  - TY4 triac is not driven by microcontroller
  - There is 0 on the display.
  - FC failure code is saved to memory

-Test can be finished by pressing On/Off button.

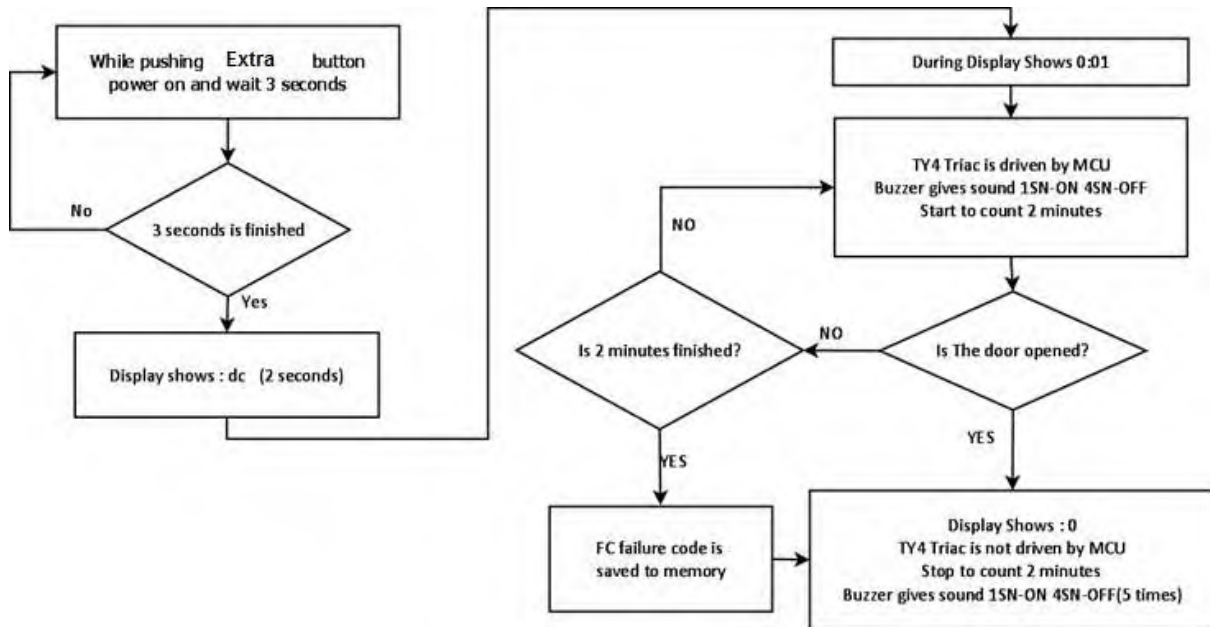

### 6.16 BLDC MOTOR CONTROL TEST(Y25, Y26, YB7\_B)

#### Button Combination for BLDC Test:

Press “Half Load” button. Switch-on the dishwasher. Keep pressing “Half Load” button for 3” After 3”, display shows “Pc” (means that Pump control) characters during 2 sec, then “20” characters appear and BLDC motor start performing with 2000 rpm.



Rpm values can be raised or decreased one by one.

Press “S/P” button to increase RPM values from 2000 to 3400.(20,21,22,...,34)

Press “Program” button to decrease RPM values by hundred from 3400 to 2000.(34,33,32,...,20)

-Test can be finished by pressing On/Off button.



### 6.17 VOICE CONTROL TEST

Button Combination for Voice Level Set:

First energize the machine via main switch (if it is in OFF position).

Press of "Delay" button for 3".

If voice controlling is done first time, at the end of 3 seconds, "S1" is shown in the display and Buzzer gives a long sound. (level of 1) (Factory setting is set to "S1")

User can open or close the voice level with "Program" and "S/P" buttons. The characters must be as follow;

By each pressing "Program" button,

- Display screen changes S1 to S0
- Level of sound is closed
- "S0" level that means all voices are off

By each pressing "S/P" button

- Display screen changes from S0 to S1
- Level of sound is opened

Machine's power must be off to exit voice control mode

The last voice level that user determined before must be stored in memory.

## 7. SERVICE TEST

Only service can execute this procedure.

Button Combination for Service Test:

- Power OFF; press Start/Stop button.
- Power ON by pressing On/Off button and continue to press Start/Stop button at least for 6".
- When "Service test" is recognized

- **For models w/o display:** All leds are ON.If model has sliding dispenser, all leds blink three times. Next, Start/Stop led blinks and service test starts.
- **For models w/ display:** All leds are ON, SP is visualized on display and service test starts. During the first 6" of test, if a failure code is stored in memory, its codification blinks. Also at the end of the test if an error occurs its error code blinks.

During the test, SP is shown.

Step		Time	Tested Load
0	Show code	6"	Before start, the code of last error is visualized (see below)
1	Drain	6"	Drain pump.
2	Fill (3l/2,5l)*	~ 1'	Flow meter; Inlet Valve;
3	Fill + Wash (0,5/1lt)**		Flow meter; Inlet Valve; Pressure Switch;
4/□	Turb. Sensor	30"	Measure of turbidity sensor
5	Wash	1'	Circulation pump; Regeneration Valve; detergent dispenser.
6	Wash + Heat ***	5'	Heater (PSW); NTC; diverter (position).
7/8	Reg. Valve + Turbo Fan	1'	Regeneration Valve + Turbo Fan
9	Water V+Drain	1'20"	Water Valve; Drain pump; Pressure switch

10	Drain	20"	Drain pump; pressure switch.
11	End	-	Code error or end led

\* 3lt in Y1; 2,5lt in Y2.

\*\* 0,5lt in Y1; 1lt in Y2.

\*\*\* In service test the unsuccessful heating failure routine works with reduced time of recognize (first measure at 2'20", second measure t 4'20")

If during the service test, the door is opened, Start/Stop led blinks (for models w/ display "SP" is shown).

If during the service test, the Start/Stop button is pressed, the program corresponding on the program leds(for models w/o display) or display(for models w/ display) position starts.

To reset the service test, press On/Off button or plug out and then plug in.

Also at the end of the test, if an error does not occur, any error code is not visualized. Machine will be standby position.

*Note: If user did not set water hardness level before service test, "SE" is shown at the beginning and end of service test.*

## 7.1 SERVICE FAILURE CODES

**For models w/o display;**

Name	Start/Stop	Wash	Rinse	Dry	End	Notes
Overflow	-	-	-	Blink	-	In the normal work is not visualized.
Leakage	-	-	Blink	Blink	-	
Drain time out	-	-	-	Blink	Blink	
Presence Flow meter impulses	-	-	Blink	-	Blink	
Absence Flow meter imp.	-	-	Blink	-	-	In the normal work is not visualized.
Empty Level	Blink	-	-	-	-	
Empty Level for new models (26.04.2020)	<b>Blink</b>	-	-	-	<b>Blink</b>	
Re-Fill time out	Blink	-	-	-	-	
NTC ca/cc	-	Blink	-	-	Blink	
Overheating	-	Blink	-	Blink	-	
Unsuccessful heating	-	Blink	-	Blink	Blink	
Parameter set salt incorrect	-	Blink	Blink	Blink	-	In the normal work this failure is not visualized.
CK Parameters	-	Blink	Blink	Blink	Blink	

HIGH VOLTAGE	-	Blink	Blink	-	Blink	
LOW VOLTAGE	-	Blink	Blink	-	-	
Turbidity Sensor	Blink	Blink	-	-	-	In the normal work this failure is not visualized.

**Note: When water tap is closed, FF failure code will be shown in new models.**

**For models w/ display;**

Name	DISPLAY	Notes
Overflow	F0	In the normal work this failure is not visualized.
Leakage	F1	
Draining time out	F2	
Presence of Flow meter impulses	F3	
Absence of Flow meter	F4	In the normal work this failure is not visualized.
Empty Level	F5	
Empty Level for new models (26.04.2020)	<b>FF</b>	
Re-Fill time out	F5	
NTC ca/cc	F6	
Overheating	F7	
Unsuccessful heating	F8	
Diverter opened	F9	
Turbidity Sensor	FA	In the normal work this failure is not visualized.
Parameter set salt incorrect	SE	In the normal work this failure is not visualized.
CK Parameter	FE	
High Voltage	HI	In the normal work this failure is not visualized.
Low Voltage	LO	In the normal work this failure is not visualized.

## 8. FAILURE ROUTINES

N°	Name	Exit of failure state	Service Call
1	Switch door open	Door closing	NO
2	Delay after door closing	7" delay before restart prg in heating step	NO
3	Overflow Leakage	Overflow signal gets off OFF/ON	NO ----- YES
4	Draining time out	OFF/ON	YES
5	Presence of Flow meter impulses	Flow Meter signal gets off. OFF/ON.	NO ----- YES
6	Absence of Flow meter impulses	Pressure switch on Full. Pressure switch on Empty. OFF/ON	NO* ----- NO/YES
7	Level Empty	Level doesn't reach full	NO/YES
8	Re-Fill	3 Re – fill in the same washing step	NO/YES
8	NTC ca/cc	OFF/ON	YES
8	Overheating	OFF/ON	YES
10	Unsuccessful heating	OFF/ON	YES
11	Diverter opened	OFF/ON	YES

12	CK Parameters	OFF/ON	YES
13	High Voltage Failure	OFF/ON	YES
14	Low Voltage Failure	OFF/ON	YES

\*Cycle could be executed with a filling time.

### **Failure Routine**

If a failure is recognized:

- Stop all devices
- Stop program flow.
- Drain Empty + 30" with circulation pump on

If the failure requires the termination of the washing program:

- Stop all the devices.
- Start to visualize the failure code.

If the failure doesn't require the termination of the washing program:

- Stop all the devices.
- Re-Start the washing program.

If it is necessary it performs the *Re-Fill routine*

### **Re-Fill Routine**

After a forced drain (ex: a failure routine) if the dishwasher was in wash before the drain it performs the re-fill routine:

- Inlet Valve ON + circulation pump OFF to load 3l (time out 420")
- When the first load step is finished, Inlet Valve ON + circulation pump ON to load 1l (time out 100")
- Return to the washing cycle

## **8.1 DESCRIPTION OF FAILURES**

### **Opened door switch**

Recognize:	if door is opened with a started program
Action	Wait
Exit	Closing door.
Service	No

Model	Start/Stop(w/o display) Delay(w/display)	Wash	Rinse	Dry	End	Display
Y1	Blink	-	...	...	-	...
Y2	Blink	-	-	-	-	...

### **Delay in re-start program**

Recognize:	if door is opened and re-closed in a heating step.
Action	Wait 5" before restart program.
Exit	Closing door.
Service	No



Recognize:	After 50" (time out) of load without impulses by the flow meter, circulation pump starts. If pressure
Action	-
Exit	-
Service	NO

Model	Start/Stop(w/o display) Delay(w/display)	Wash	Rinse	Dry	End	Display
Y1 w/o display	-	-	Blink	-	-	... (F4)
Y1 w/ display, Y2	All leds blink					F4

#### **Level Empty without Flow meter impulses (perhaps Tap close)**

Recognize:	After water load starts, if pressure switch doesn't go to full level in 150".
Action	Go to Failure routine.
Exit	OFF/ON
Service	NO if tap is closed. YES in the other cases.

Model	Start/Stop(w/o display) Delay(w/display)	Wash	Rinse	Dry	End	Display
Y1 w/o display	Blink	-	-	-	-	...(F5)
Y1 w/ display, Y2	All leds blink					F5

<b>For new models</b> (26.04.2020)	Start/Stop(w/o display) Delay(w/display)	Wash	Rinse	Dry	End	Display
Y1 w/o display	<b>Blink</b>	-	-	-	<b>Blink</b>	...(FF)
Y1 w/ display, Y2	All leds blink					<b>FF</b>

#### **Rarely flow meter impulses (perhaps low water pressure)**

Recognize:	With rarely flow meter impulses (time out of absence of flow meter impulses doesn't expire) it doesn't reach the first quantity of required water (2,5l) within the time out (420")
Action	Go to Failure routine.
Exit	OFF/ON
Service	Not necessary if the reason is a momentary. YES in the other cases.

Model	Start/Stop(w/o display) Delay(w/display)	Wash	Rinse	Dry	End	Display
Y1 w/o display	Blink	-	...	...	-	...(F5)
Y1 w/ display, Y2	All leds blink					F5

<b>For new models</b> (26.04.2020)	Start/Stop(w/o display) Delay(w/display)	Wash	Rinse	Dry	End	Display
Y1 w/o display	<b>Blink</b>	-	-	-	<b>Blink</b>	...(FF)
Y1 w/ display, Y2	All leds blink					<b>FF</b>

#### **Level Empty and rarely Flow meter impulses**

Recognize:	With rarely flow meter impulses (time out of absence of flow meter impulses doesn't expire) it doesn't reach the second quantity of required water related to the washing cycle) within the time out (100")
Action	Go to Failure routine.
Exit	OFF/ON
Service	Not necessary if the reason is a momentary. YES in the other cases.

Model	Start/Stop(w/o display) Delay(w/display)	Wash	Rinse	Dry	End	Display
Y1 w/o display	Blink	-	...	...	-	...(F5)
Y1 w/ display, Y2	All leds blink					F5

#### **Level Empty and regular/rarely Flow meter impulses**

Recognize:	With flow meter impulses (time out of absence of flow meter impulses doesn't expire) it reaches the second quantity of required water related to the washing cycle) but it doesn't reach the full level within the time out (30")
Action	Go to Failure routine.
Exit	OFF/ON
Service	Not necessary if the reason is a momentary. YES in the other cases.

Model	Start/Stop(w/o display) Delay(w/display)	Wash	Rinse	Dry	End	Display
Y1 w/o display	Blink	-	...	...	-	...(F5)
Y1 w/ display, Y2	All leds blink					F5

#### **Re-Fill**

Recognize:	During a washing step, if pressure switch goes from full level to empty level Failure routine start. Wash restarts with the Re-Fill routine (3l+1l). If pressure switch goes from full level to empty level for 3 times during the same washing step failure is recognized.
Action	Go to Failure routine.
Exit	OFF/ON
Service	Not necessary if the reason is a momentary (ex. an upside down pot). YES in other situations.

Model	Start/Stop(w/o display) Delay(w/display)	Wash	Rinse	Dry	End	Display
Y1 w/o display	Blink	-	...	...	-	...(F5)
Y1 w/ display, Y2	All leds blink					F5

#### **NTC open or short-circuit**

Recognize:	Recognition of open or short-circuit NTC (-20°C/86°C). Test is executed during all the program flow.
Action	Go to Failure routine.
Exit	OFF/ON

Service	YES
---------	-----

Model	Start/Stop	Wash	Rinse	Dry	End	Display
Y1 w/o display	-	Blink	-	-	Blink	...(F6)
Y1 w/ display, Y2	All leds blink					F6

### **Overheating**

Recognize:	Water temperature $\geq 77^{\circ}\text{C}$ . The test is done during all the cycle.
Action	Go to Failure routine.
Exit	OFF/ON
Service	YES

Model	Start/Stop(w/o display) Delay(w/display)	Wash	Rinse	Dry	End	Display
Y1 w/o display	-	Blink	-	Blink	-	...(F7)
Y1 w/ display, Y2	All leds blink					F7

### **Unsuccessful heating**

Recognize:	During the heating phases, after the first 420", if water temperature increases less than $2^{\circ}\text{C}$ or if it is less than $0^{\circ}$ . The first valid value to check is read after 120" from the beginning of the heating step. The test is executed only if the measured temperature is lower than $60^{\circ}$ . After door opened and reclosed during heating, temperature and time value which are read before door is opened must be cleared. Also, the control routine will start from beginning of failure routine.
Action	Skip the heating step. The test is repeated in all the heating steps. If in a following step, the heating is OK the failure is cleared. The failure is shown at the end of the program.
Exit	OFF/ON
Service	YES

Model	Start/Stop	Wash	Rinse	Dry	End	Display
Y1 w/o display	-	Blink	-	Blink	Blink	...(F8)
Y1 w/ display, Y2	All leds blink					F8

Note: F8 is not sensed and shown in Jetwash 14' program.

### **Diverter Open Circuit(only Y2)**

Recognize:	30" with motor of diverter valve ON and diverter sensing doesn't change
Action	Go to Failure routine.
Exit	OFF/ON
Service	YES

Model	Start/Stop	Wash	Rinse	Dry	End	Display
Y2	All leds blink					F9

### **Turbidity (Y24, Y25, Y26)**

Model	Start/Stop	Wash	Rinse	Dry	End	Display
Y24	All leds blink					FA

**Voltage failure**

Recognize:	If the card detect high or low voltage level from main supply
Action	Stop the program . After 3 hours Go to Failure Rutine and show failure code.
Exit	OFF/ON
Service	YES

**High Voltage Failure:** When high voltage (Above 285V, then 275-285VAC) detected during 3 hours

Model	Start/Stop(w/o display) Delay(w/display)	Wash	Rinse	Dry	End	Display
Y1 w/o display	-	Blink	Blink	-	Blink	...
Y1 w/ display, Y2	All leds blink					HI

**Low Voltage Failure:** When low voltage (blow 145V, then 145-155VAC) detected during 3 hours

Model	Start/Stop(w/o display) Delay(w/display)	Wash	Rinse	Dry	End	Display
Y1 w/o display	-	Blink	Blink	-	-	...
Y1 w/ display, Y2	All leds blink					LO

**Parameters Set Salt Incorrect**

Recognize:	When parameter Set Salt is uncorrected
Action	Go to Failure routine.
Exit	OFF/ON
Service	NO

Model	Start/Stop(w/o display) Delay(w/display)	Wash	Rinse	Dry	End	Display
Y1 w/o display	-	Blink	Blink	Blink	-	...(SE)
Y1 w/ display, Y2	All leds blink					SE

**Parameters Check Sum**

Recognize:	When parameter Check sum is uncorrected
Action	Go to Failure routine.
Exit	OFF/ON
Service	The problem would disappear after switch OFF/ON of the dishwasher. If it doesn't disappear YES.

Model	Start/Stop(w/o display) Delay(w/display)	Wash	Rinse	Dry	End	Display
Y1 w/o display	-	Blink	Blink	Blink	Blink	...
Y1 w/ display, Y2	All leds blink					FE

**Auto Door Failure(Y25)**

Recognize:	When auto door mechanism is activated, the door is not opened
Action	Go to Failure routine.
Exit	OFF/ON
Service	NO

Model	Start/Stop(w/o display) Delay(w/display)	Wash	Rinse	Dry	End	Display
Y25	All leds blink					FC

## 8.2 FAILURE CODES

Coding failure for models without display:

N°	Name	Start/Stop	Wash	Rinse	Dry	End
1	Door open	Blink	-	-	-	-
2	Delay before Door closing	-	-	-	-	-
3	Overflow	-	-	-	-	-
	Leakage	-	-	Blink	Blink	-
4	Drain time out	-	-	-	Blink	Blink
5	Empty Level	Blink	-	-	-	-
5	Empty Level ( <b>FF, for new models, 26.04.2020</b> )	<b>Blink</b>	-	-	-	<b>Blink</b>
6	Re-Fill time out	Blink	-	-	-	-
7	Presence Flow meter impulses	-	-	Blink	-	Blink
8	Absence Flow meter imp. With Full	-	-	-	-	-
	Absence Flow meter imp. Without Full	-	-	Blink	-	-
9	NTC ca/cc	-	Blink	-	-	Blink
10	Overheating	-	Blink	-	Blink	-
11	Unsuccessful heating	-	Blink	-	Blink	Blink
12	CK Parameters	-	Blink	Blink	Blink	Blink
13	High voltage	-	Blink	Blink	-	Blink
14	Low voltage	-	Blink	Blink	-	-

Coding failure for models with display:

N°	Name	S/P	Display	All leds
1	Door open	Blink	-	
2	Delay before Door closing	-	-	
3	Overflow	-	-	
	Leakage	-	F1	Blink
4	Drain time out	-	F2	Blink
5	Re-Fill time out		F5	Blink
6	Presence Flow meter imp.		F3	Blink
7	Absence Flow meter imp. With Full		-	
	Absence Flow meter imp. Without Full		<b>F5/FF(for new models, 26.04.2020)</b>	Blink
8	NTC ca/cc		F6	Blink
8	Overheating		F7	Blink
10	Unsuccessful heating*		F8	Blink

11	Diverter opened		F9	Blink
12	CK Parameters		FE	Blink
13	Parameter set salt incorrect		SE	Blink
14	Turbidity Sensing		FA	Blink
15	Auto Door Failure		FC	Blink
16	High Voltage Failure		(HI)	Blink
17	Low Voltage Failure		(LO)	Blink

## 9. END TEST

End test is divided in two parts: end test 1 (functionally test) and end test 2 (heating and leakage test).

### **End test 1:**

Vestel receives the electronic cards ready to start "end test 1". In any case, it's possible, re-start the end test 1 with a manual manoeuvre.

#### Button Combination for End Test:

- Power OFF; press Program button or Start/Stop button.
- Power ON and continue to press Program button and Start/Stop button at least for 3".

When "End test 1" is recognized

- **For models w/o display:** All leds are ON and then all leds are ON( salt and rinse aid leds are ON if there is no salt and rinse aid)
- **For models w/ display:** All leds are ON, EP is shown on display and then all leds are ON, 188 is shown on display

-After end test starts, All digits and all leds should be on together at the beginning of the end test-1 (display also show 188) during first 3 seconds.

**-Deterjan dispenseri sonrasında 188 olarak display segmentleri aktif edilir.**

- At the end of end test 1, switch OFF the dishwasher.

-To skip the End test1, press Start/Stop button for 3 sec.

Diverter failure: Stop circulation pump just after detergent dispenser activation at step 41 until the end of program if electronic card cannot detect diverter position during end test 1.

Turbidity failure: Start circulation pump just after turbidity sensor check (at step 92) for 6 sec, if electronic card realize Turbidity sensor failure during turbidity test.

If we open/close the door during end test, End test continues from the point on which we open/close the door. End test combinations keep performing.

-Salt indicator and rinse aid indicator is ON if reed sensors are short cut during end test END TEST 1 or END TEST2

-Salt indicator and rinse aid indicator is OFF if reed sensors are not short cut during end test END TEST 1 or END TEST

**Note:** In cases where the machine is energized, On/Off led is ON. However, there is a special case such that if On/Off led does not exist in model codification, the led is OFF. If the led is included in the codification, On/off led is ON. After codification ended, On/Off led is ON since machine is energized.

## **End test 2**

When the electronic card is switched on after the end test 1, end test 2 starts.

- 4" of pause
- Heating to reach 62°C with 13' of time out
- Only circulation pump is on for 10" sec
- Drain + Regeneration valve is on 20"
- End test 2 is finished.

During this phase, failure routine of unsuccessful heating and failure routine of NTC works. If the water temperature doesn't increase, at the end of 15', the drain pump will be on.

When the electronic card is switched on after end test 2, it will be in washing mode.

At the end of end test 2, machine turns to standby position(Eco program is shown as default).

**Note:** During check of Turbidity and Diverter position in the End Test1, if there occurs error, electronic card will save these errors and will go to the failure routine at the beginning of END test 2 ( as NTC failure recognition)

## **10.HARDWARE CONTROLS**

### **10.1 BM12 RÖLE KARTI**

#### **1.4.2020 tarihinden itibaren çalışılan tüm Avrupa yazılımlarında;**

Y serisi BLDC modeller için; BM02kart ve BM12 röle kartı ile sürülme durumunda BM12 kart data kontrolü BM02/CN20.2 'den yapılır

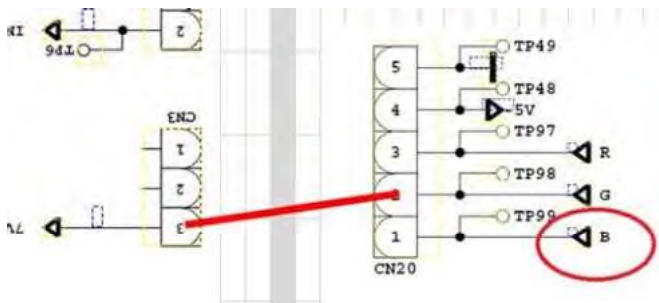

# ELECTRICAL COMPONENTS

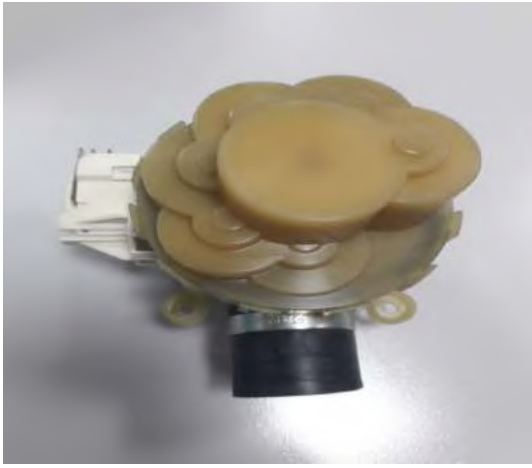

**AQUAZONE**

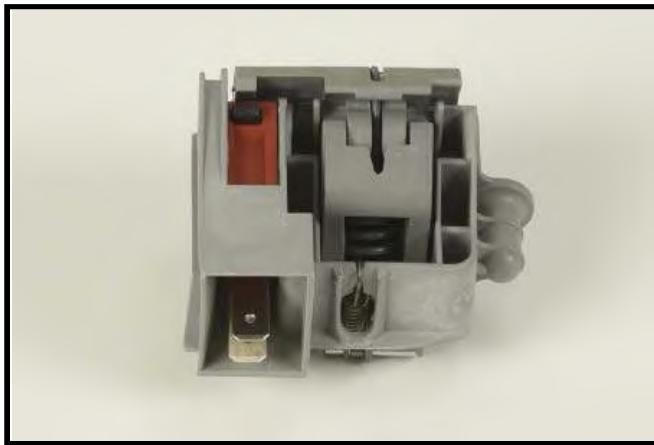

**DOOR LOCK**

It is a mechanical lock/release system that is closing the door, supplying the connection of electrical parts in the machine and cutting off the connection.

Currency 16 (4) A

## CIRCULATION PUMP

Voltage	220/240
Frequency	50HZ
Total Power	90W
Coil Isolation Class	F
Thermal Protector	150°C
Pump Outlet Pressure	300mbar
Pump Flowrate	60 lt/min

Measurement of the primary windings of the washing pump. (118.2-135.9 Ω)

Measurement of the secondary windings of the washing pump (white cable – blue cable)(117.9-135.6 Ω)

Single direction, single phase, asynchronous and two pole.

It turns opposite clock direction.

It is assembled to the basement with rubber hangers.



## FLOATER



	C		T		
PRESSURE SWITCH	CN2.10 - CN2.2	0 Ω ∞Ω	KN2.9 - KN2.10	0 Ω ∞Ω	WATER NO WATER

## PRESSURE SWITCH

Voltage 220/240 v

Frequency 50/60 Hz

16 A - 3 Pins

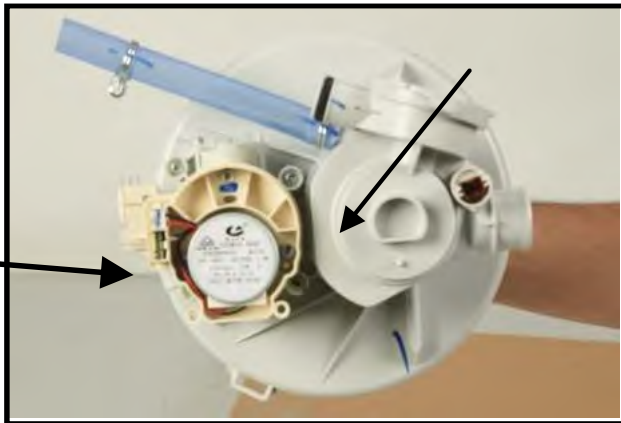
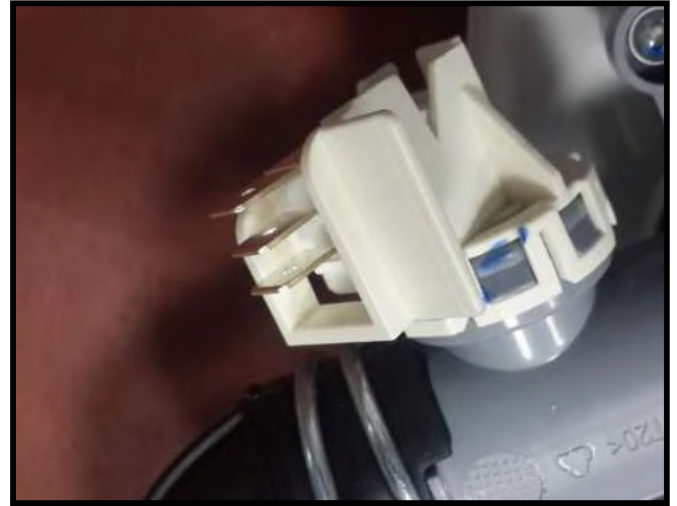

## DIVERTER

There is diverter at A15 and A23 models It is assembled to the heater Casing Group.

Voltage	220/240 V
Frequency	50 Hz
Power	8W
Resistance	10500 ± %5 Ω

## WATER INLET VALVE

Single inlet and single outlet standard single coil selenoid valve.

Voltage	220 - 240
Total Power	6W
Flowrate	2,5 ±% 15 lt/dk
Coil Isolation Class	H
Resistance	4200 ±%10



It is assembled to the basement and connect to the airbreak by hose.



## **BLDC MOTOR**

### **UPPER SPRAY ARM**

It distributes water from upper spray arm to dirty dishes in the upper basket.

It provides to wash the dishes in the upper basket through turning by the holes with various angles.



### **LOWER SPRAY ARM**

It distributes water from lower spray arm to dirty dishes in the lower basket.

It provides to wash the dishes in the lower basket through turning by the holes with various angles.



## CAPACITOR

2,5  $\mu$ F - 450 V class S2

Capacitor is permanently connected to the circulation pump coils.

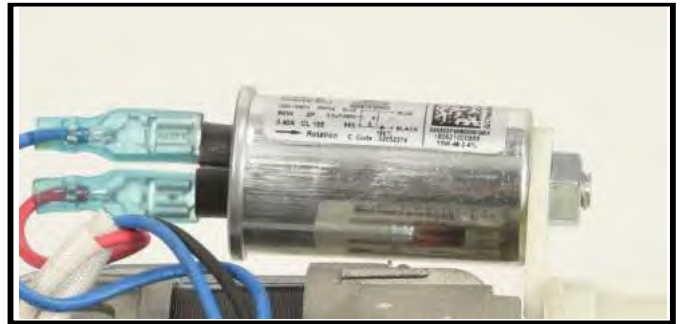

## DRAIN PUMP



Voltage	220/240 volt
Frequency	50Hz
Flowrate	30W
Coil Resistance / Hanyu	220 $\Omega$ % $\pm$ 7
Coil Resistance / Leili	141 $\Omega$ % $\pm$ 7
Coil Isolation Class	F
Thermal Protector	120 $^{\circ}$ C

## HEATER

Voltage 220/240 volt

Total power 1800W

27.6-30.6 ohm

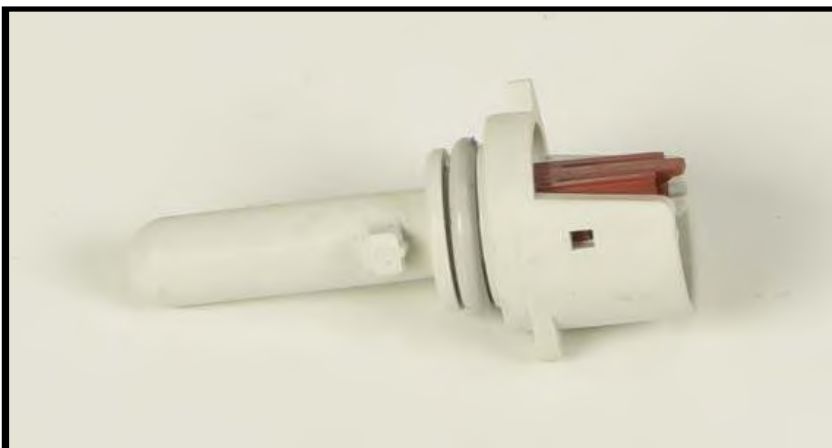
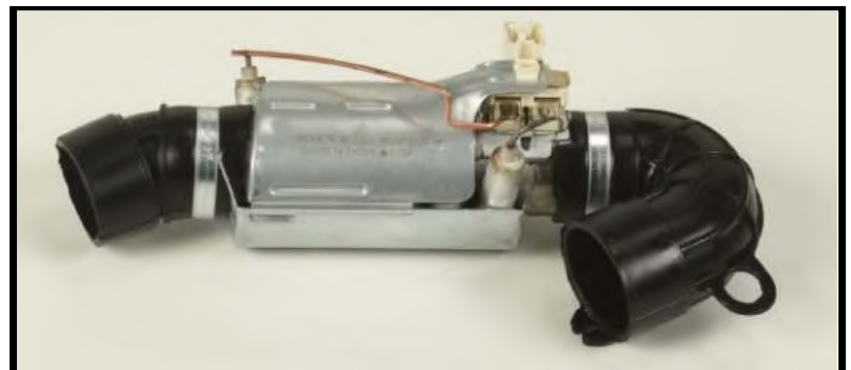

## NTC

+25 $^{\circ}$ C	-	47.200	$\pm$	850 $\Omega$
+30 $^{\circ}$ C	-	37.500	$\pm$	675 $\Omega$
+40 $^{\circ}$ C	-	24.900	$\pm$	349 $\Omega$
+50 $^{\circ}$ C	-	17.000	$\pm$	170 $\Omega$
+60 $^{\circ}$ C	-	11.700	$\pm$	117 $\Omega$
+70 $^{\circ}$ C	-	8.280	$\pm$	108 $\Omega$
+80 $^{\circ}$ C	-	5.945	$\pm$	101 $\Omega$

# **FAILURE CODES (Possible Problems)**

## **F1 (ALARM IS ACTIVE FOR OVERFLOW)**

### **FLOATER**

- Floater switch can be out of order or have a problem with the cable connection.

### **TUB**

- There can be a water leakage from the tub

### **ELECTRONIC CARD**

- Electronic card can be out of order.

## **F2 (THE WASTE WATER IN THE MACHINE CANNOT BE DISCHARGED)**

### **Drain hose**

- Water outlet hose is clogged
- Check of the water outlet hose position.

### **Drain pump**

- Check the drain pump resistance and power values
- There can be a problem with cable connection of the drain

### **Pressure switch**

- Pressure switch of the heater casing group can have a mechanical or cable connection problem.

## **F3 (ERROR OF CONTINUOUS WATER INPUT)**

### **Water inlet valve**

- Water inlet valve can be out of order or can not be closed.

### **Electronic card**

- Electronic card can be out of order.

## **F4 (FLOWMETER FAULTY)**

### **Flowmeter**

- Flowmeter can be out of order.
- Cable connection of flowmeter can be faulty.

### **Electronic card**

- Electronic card can be out of order.

## **FF (INADEQUATE WATER SUPPLY)** (Valid after the August 2020 update)

### **Water tap**

- Make sure the water input tap is totally open and that there is no water cut.

### **Water inlet hose**

- Close the water input tap, separate the water input hose from the tap and clean the filter at the connection end of the hose.

### **Water inlet valve**

- Water inlet valve filter can be clogged
- Water inlet valve can be out of order. There can be a problem with the cable connection of water inlet valve.

## **F5 (PRESSURE SYSTEM FAILURE)**

### **Floater**

- Floater switch can be out of order or have a problem with the cable connection.

### **Pressure switch**

- Pressure switch of the heater can have a mechanical or cable connection problem.

### **Circulation pump**

- Circulation pump can be out of order or have a problem with the cable connection. External part can be blocked to the circulation pump.

## **F6 (NTC FAULTY)**

### **Ntc**

- Ntc can be out of order.
- Ntc cable connection can be faulty. Ntc can be short or open circuit.

### **Electronic card**

- Check the power and resistance value of heater.
- Check the cable connection of the heater.
- There may be an explosion in the NTC triac region on the electronic card.
- The electronic card may be deformed.

### **CABLE HARNESS**

- There may be a problem caused by the disconnection between the cable tree, NTC and electronic board.

**NOTE: If the NTC part is faulty, it will not resist in any way.**

## **F7 (EXTREME HEATING UP FAULTY)**

### **Ntc**

- If the water temperature inside machine higher than 77°C, ntc can be out of order.

### **Electronic card**

- Electronic card can be out of order.

## **F8 (INADEQUATE HEAT)**

### **Heater**

- Check the power and resistance values.
- Check the cable connection of the heater.

### **Electronic card**

- Check the electronic card

## **F9 (DIVERTER POSITION PROBLEM)**

### **Diverter**

- Check the values of the diverter.
- Check the cable connection of the diverter.

### **Electronic card**

- Check the electronic card

## **FA (TURBIDITY SENSOR FAULTY)**

### **Turbidity sensor**

- There can be some soil around the turbidity sensor.
- Check the cable connection of the turbidity sensor.

### **Electronic card**

- Check the electronic card.

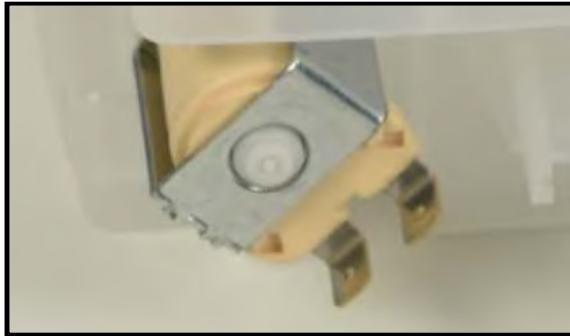
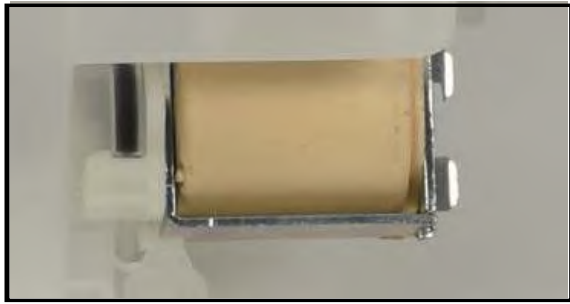

## REGENERATION VALVE

Voltage	220/240 V
Frequency	50/60 Hz
Total power	6 W
Resistance	$3560 \pm \% 10 \Omega^{\circ}\text{C}$

Regeneration valve is assembled on the water softener.

## PARASITE FILTER

Voltage	220/240
Frequency	50/60 Hz

$0,1 \mu\text{F (X1)} + 2 \times 2,2 \mu\text{F (Y2)} + 1\text{M}\Omega$

It is used to prevent parasites from the main supply It has been assembled to basement.

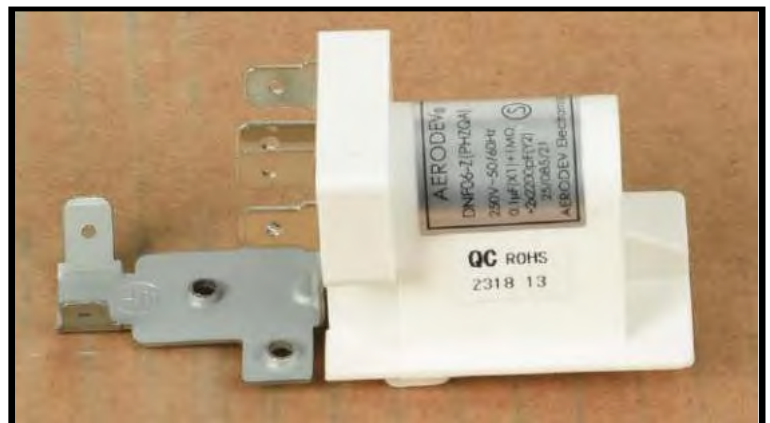

## TURBO FAN MOTOR

There is a thermal protector shaded pole motor, two pole temperature is between  $-40-150^{\circ}\text{C}$

There is turbo fan motor only at A models.

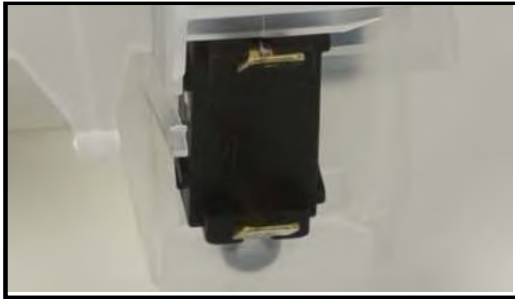

## SALT SENSOR

Voltage	250 V
Current	50 mA



It is assembled to the water softener. It warns if the salt is less than requested quantity.

## POWER CORD

Type	Euro 300-1mm <sup>2</sup> copper conducting
Isolation	Ts 670UmC 5W x P
Plug	Ts-1B73052M-2PNC Injected
Length	1260mm

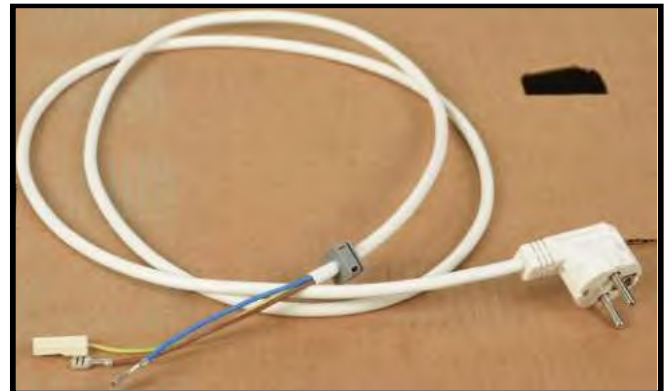

## DRAIN HOSE



Drain hose maximum height	110 cm
Drain hose minimum height	50 cm
Drain hose maximum length	400 cm
Total Power	15 W
Voltage	220/240 V
Frequency	50 Hz
Resistance	238.6± %5 Ω

# COMPONENT VALUES MEASUREMENT

**Precaution: Always** remove the plug from the power socket before touching internal components.

## WASHING PUMP:

**From the electrical card:**

You can only measure the primary winding value from the electrical card. Resistance value of the primary winding must be

	C	T	
CIRCULATION PUMP	CN2.3 - CN2.9	KN2.3 - KN 2.8	Primary winding Secondary winding (from the component)

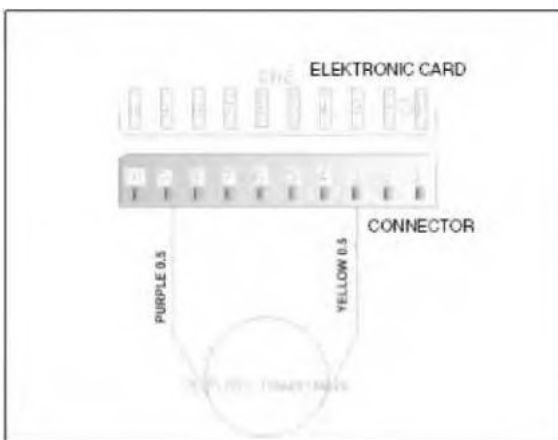

Above sketch show the connectors of the washing pump on the electrical card. Probes of the tester should be applied on to the related connectors.

**From the component:**



Measurement of the primary windings of the washing pump. (118.2-135.9  $\Omega$ )



Measurement of the secondary windings of the washing pump (white cable – blue cable) (117.9-135.6  $\Omega$ )

Probes of the tester should be applied on to the related connectors as shown on the pictures.

# FAN MOTOR

From the electrical card:

	C	T
FAN MOTOR	CN 6.2 - CN 2.9	KN 6.2 - KN 2.8

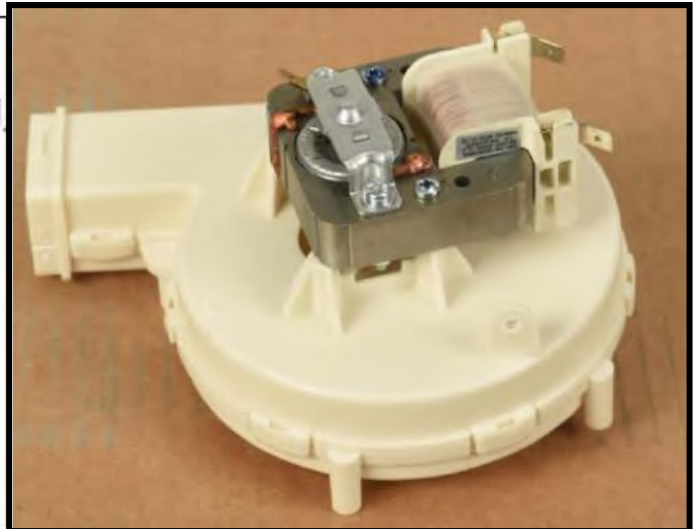
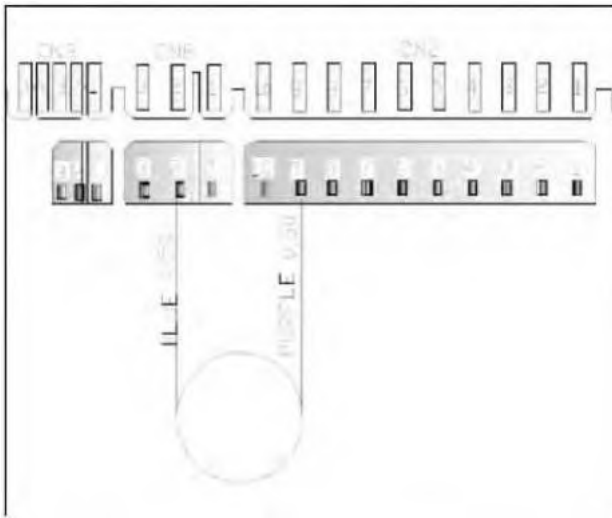

Above sketch shows the connectors of the fan motor on the electrical card.

From the component:



Turbo fan resistance value:  $265 \pm 10\% \Omega$  (The resistance of the turbo fan is measured with the resistor switch).

# DOOR SWITCH

From the electrical card:

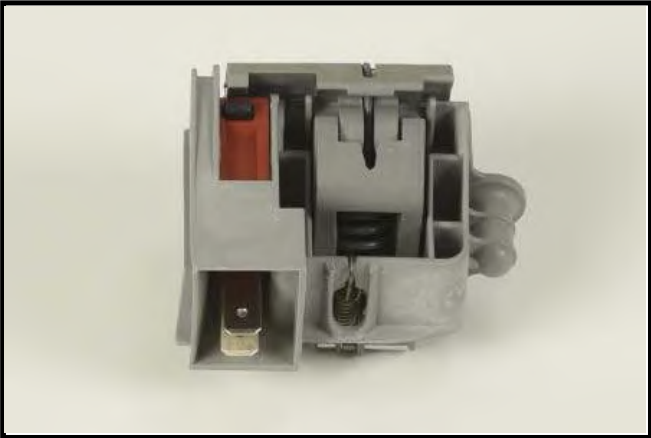
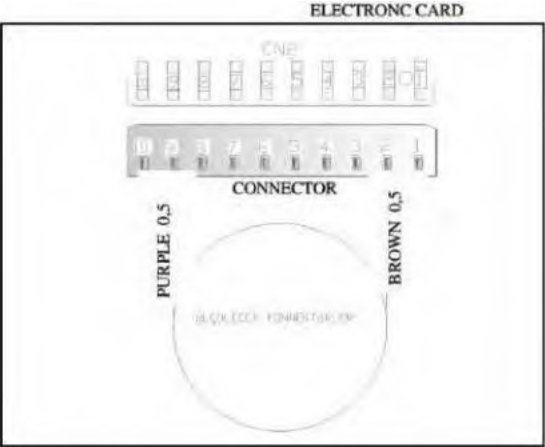

Above sketch show the connectors of the door switch on the electrical card.

From the component:

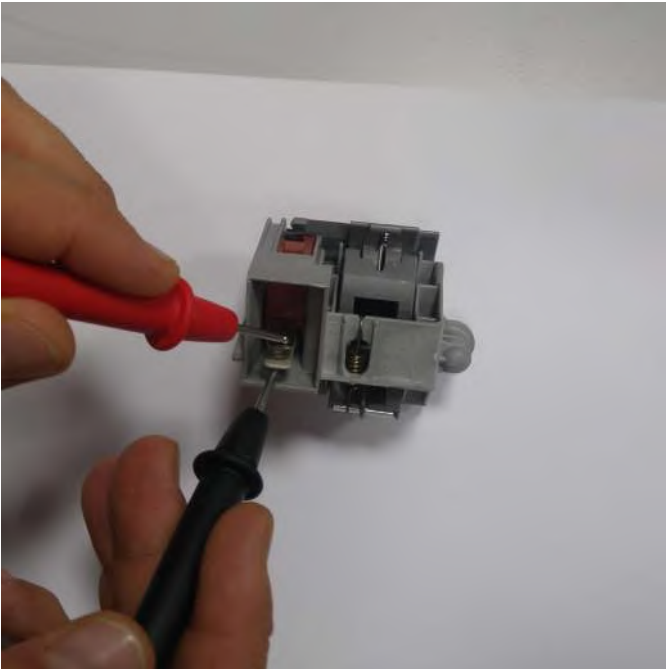

Probes of the tester should be applied on to the related connectors as shown on the pictures.

## SALT SENSOR

From the electrical card:

		C		T	
SALT SENSOR	CN5.1 - CN5.2	0 Ω NO SALT ∞Ω THERE IS SALT	KN50.10 - KN 50.11	0 Ω NO SALT ∞Ω THERE IS SALT	Measure just on the electronic

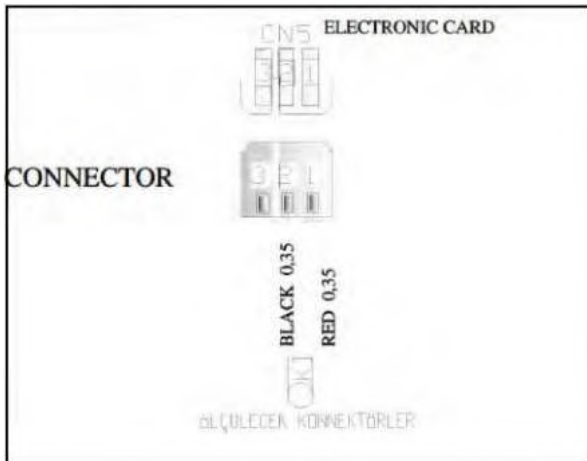

Sketch above show the connectors of the salt sensor on the electrical card. Probes of the tester should be applied on the related connectors.

From the component:



salt sensor can also be measured from the water softener when the salt sensor is assembled on the water softener.

Probes of the tester should be applied on to the related connectors as shown on the pictures.

# DIVERTER

From the electrical Card:

	C	T
DIVERTER	CN 6.1 - CN 2.9 10500 ± %7 Ω	KN 6.1 - KN 2.8 10500 ± %7 Ω

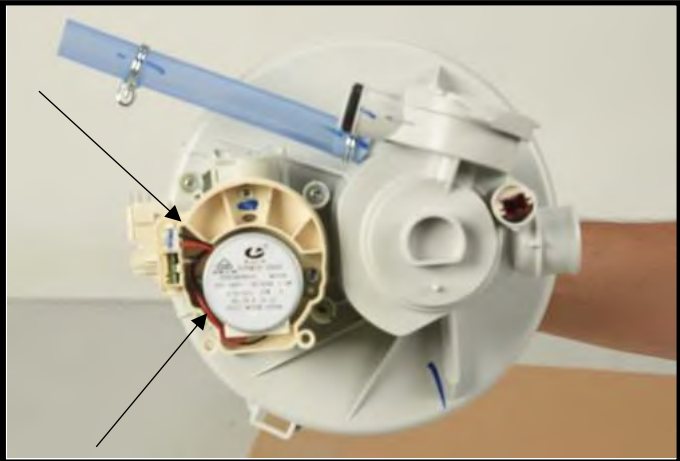
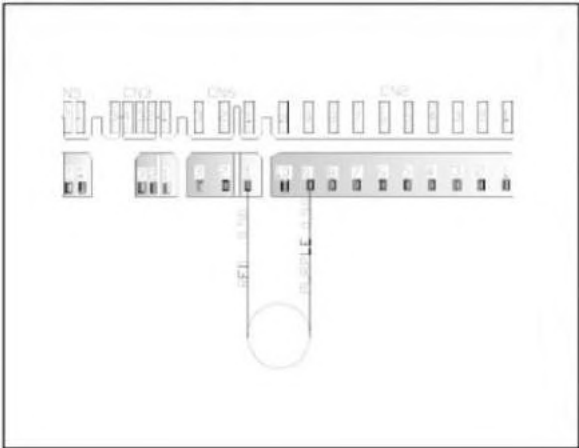

Sketch above show the connectors of the diverter on the electrical card. Probes of the tester should be applied on to the related connectors.

From the component:



Probes of the tester should be applied on to the related connectors as shown on the pictures.

# PRESSURE SWITCH

From the electrical card:

		C		T	
PRESSURE SWITCH	CN2.10 - CN2.2	0Ω ∞Ω	KN2.9 - KN2.10	0Ω ∞Ω	Full fill water no water

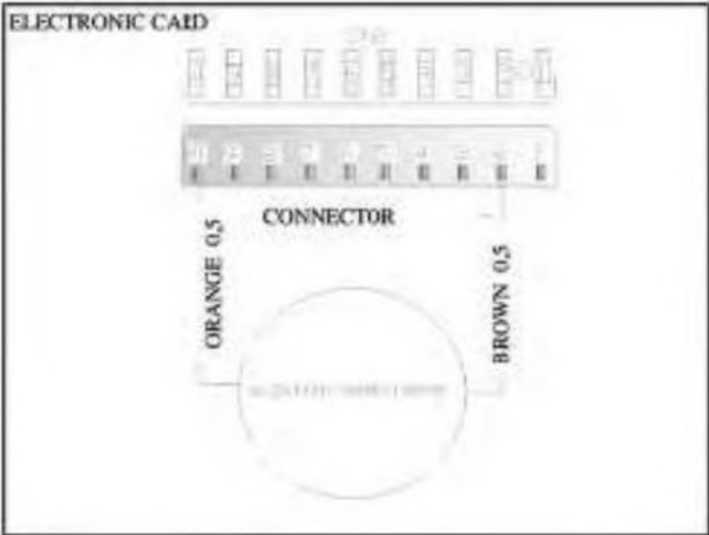

From the component:



Probes of the tester should be applied on to the related connectors as shown in the picture above.

# REGENERATION VALVE

From the electrical Card:

	C	T
REGENERATION VALVE	CN2.2 - CN2.7 3560 Ω ± %10(25°C)	KN2.2 - KN2.10 3560 Ω ± %10(25°C)

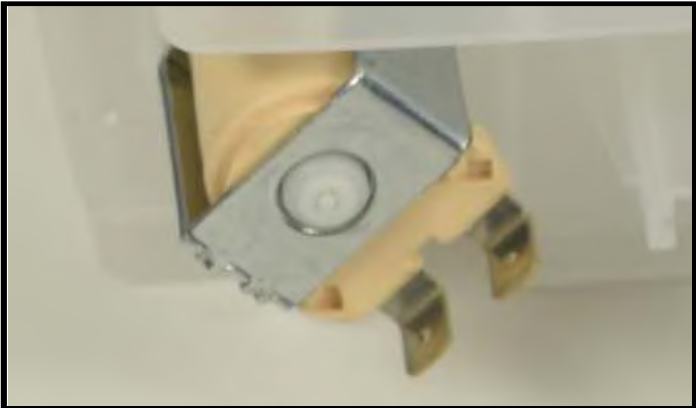
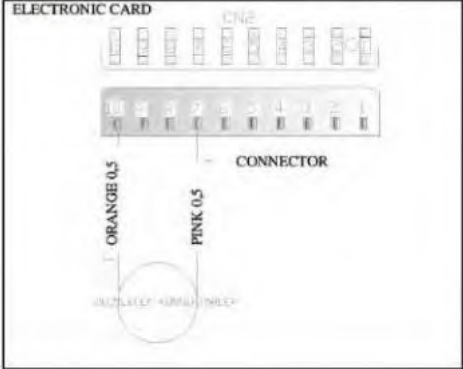

Above sketch show the connectors of the regeneration valve on the electronic card. Probes of the tester should be applied on to the related connectors.

From the component:



## HEATER

It can't be measured from the electrical card.

**From the component:**

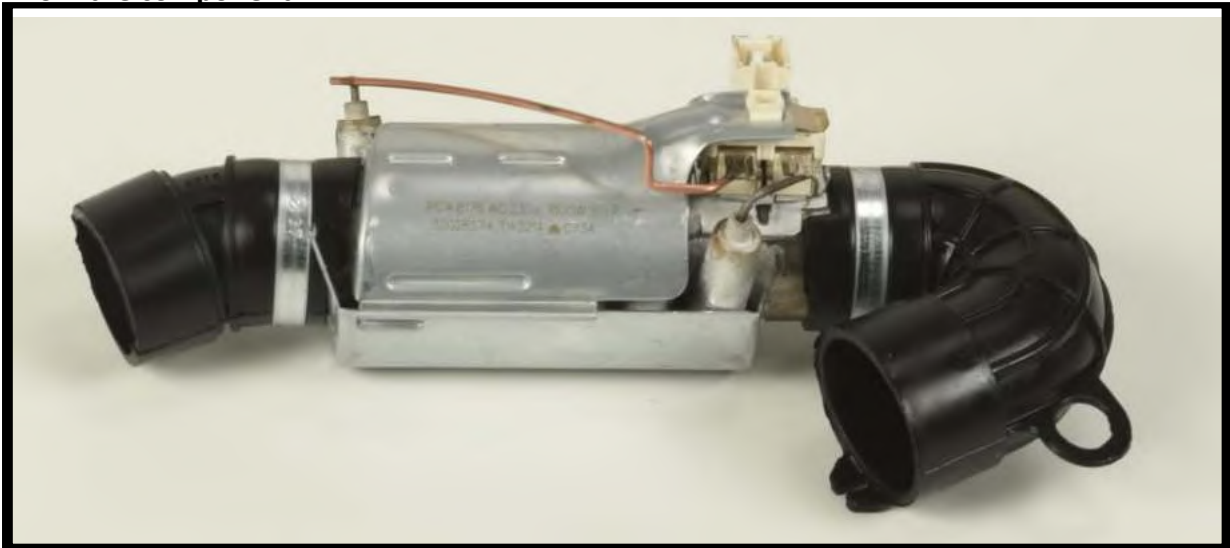

## DETERGENT DISPENSER

It can't be measured from the electrical card:

	C	T
DETERGENT DISPENSER	$2300 \Omega \pm 10\%$ (25 C°)	$2300 \Omega \pm 10\%$ (25 C°)

**From the component:**

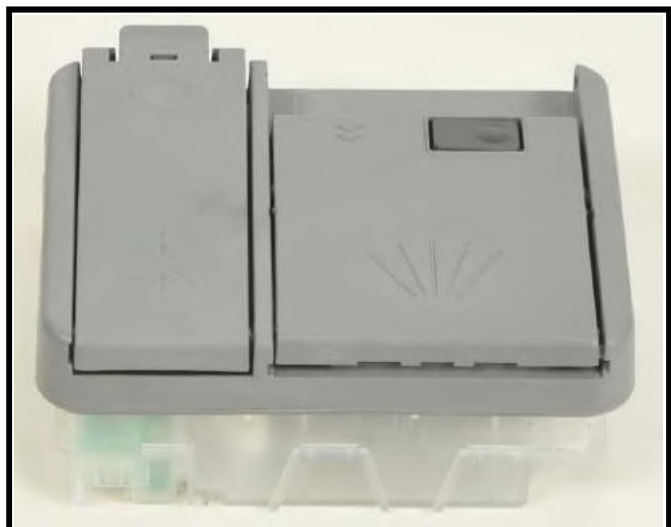

# WATER INLET VALVE

From the electrical Card:

	C	T
WATER INLET VALVE	CN2.6 - CN2.9 4200 Ω ± %10 (20°C)	KN2.6 - KN2.8 4200 Ω ± %10 (20°C)

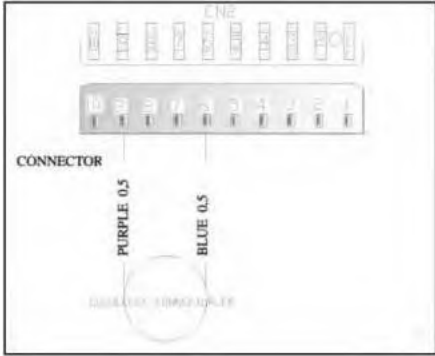

Above sketch show the connectors of the water inlet valve on the electrical card. Probes of the tester should be applied on the related connectors.

From the component:



Probes of the tester should be applied on to the related connectors as shown on the pictures.

# DRAIN PUMP

From the electrical Card:

	C	T
DRAIN PUMP / HANYU	CN2.2 - CN2.4 220 Ω % ±10	KN2.4 - KN2.
DRAIN PUMP / LEILI	CN2.2 - CN2.4 141 Ω % ±10	KN2.4 - KN2.

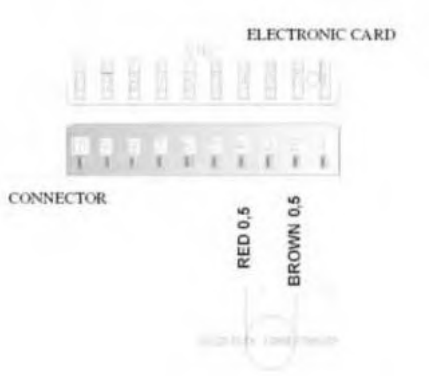

Above sketch show the connectors of the drain pump on the electrical card. Probes of the tester should be applied on to the related connectors.

From the component:



Probes of the tester should be applied on the related connectors as shown on the pictures.

# RINSE AID SENSOR

From the electrical card:

		C		T	
RINSE AID SENSOR	CN 5.3 - CN 5.2	0 Ω NO RINSE AID ∞ Ω THERE IS RINSE AID	KN 50.8 - KN 50.9	0 Ω NO RINSE AID ∞ Ω THERE IS RINSE AID	Rinse aid off Rinse aid on

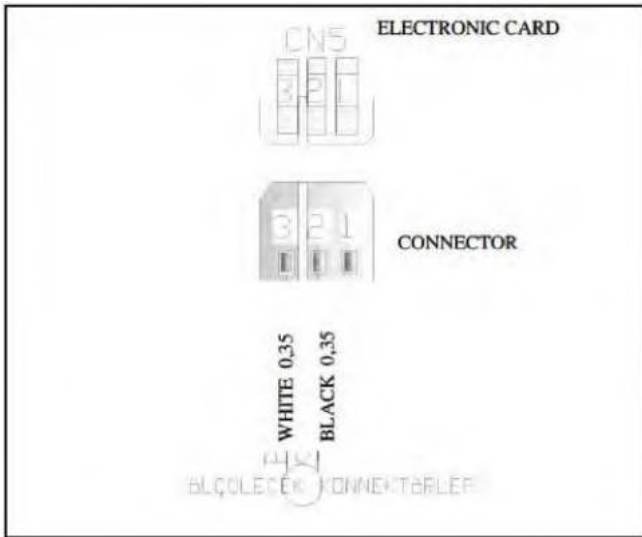

Above sketch shows the connectors of the rinse aid sensor on the electrical card.

From the component:

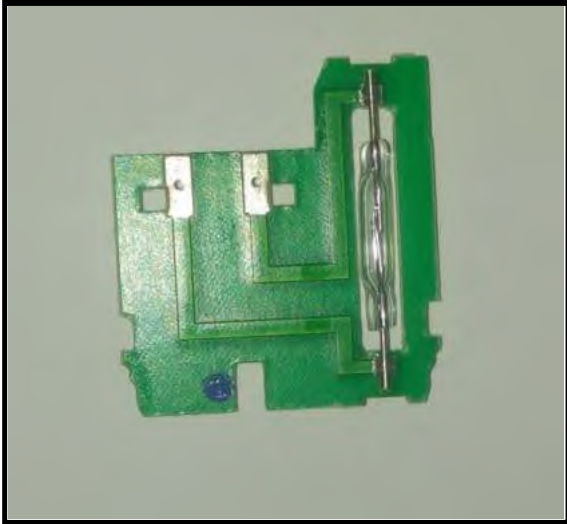
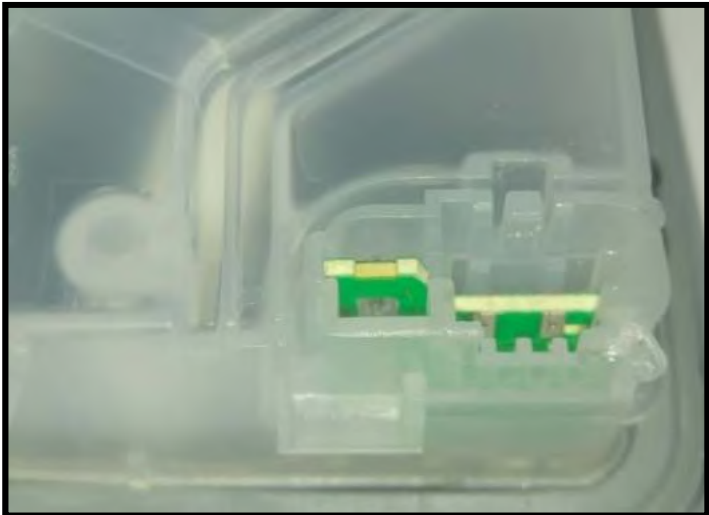

Probes of the tester should be applied on to the relatde connectors as shown on the pictures.

# FLOATER

From the electrical card:

		C	T	
FLOATER (MICROSWITCH)	CN2.1 - CN 2.5 CN2.1 - CN 2.4	0 Ω ∞ Ω	KN2.5 - KN 2.10 KN2.4 - KN 2.5	0 Ω ∞ Ω Microswitch is inactive (no water) microswitch is active (there is water)

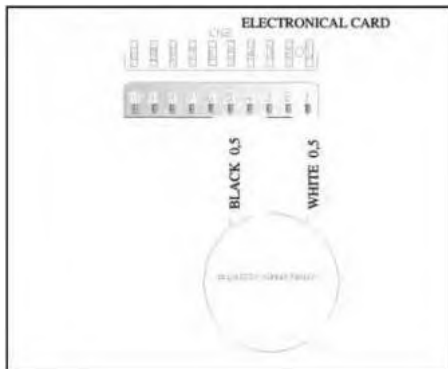
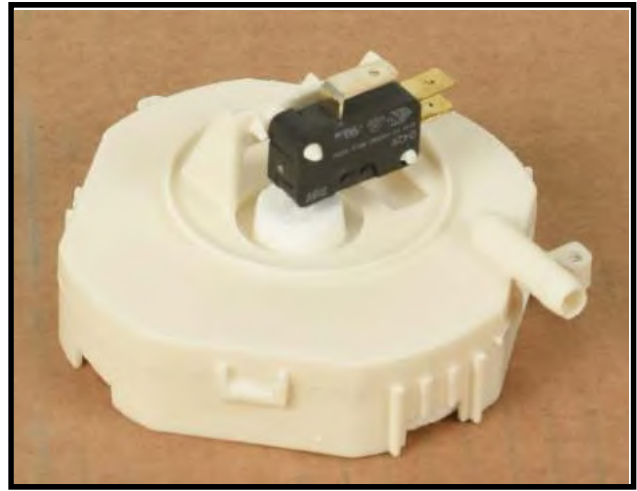

**Position 1** : You can check the floater by controlling the specified value intervals.

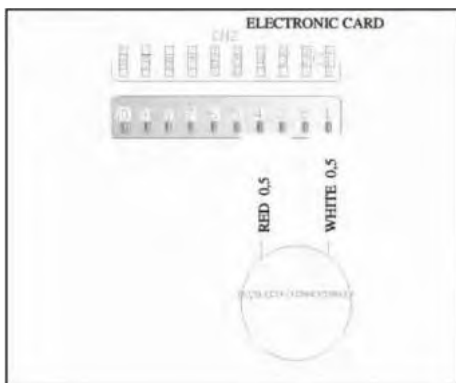

**Position 2** : If failure code is occurred related with the floater within control the above values: You can figure out whether leakage occurs or not.

## SALT SENSOR

From the electrical card:

	C		T		
SALT SENSOR	CN5.1 - CN5.2	0 Ω NO SALT ∞Ω THERE IS SALT	KN50.10 - KN 50.11	0 Ω NO SALT ∞Ω THERE IS SALT	Measure just on the electronic

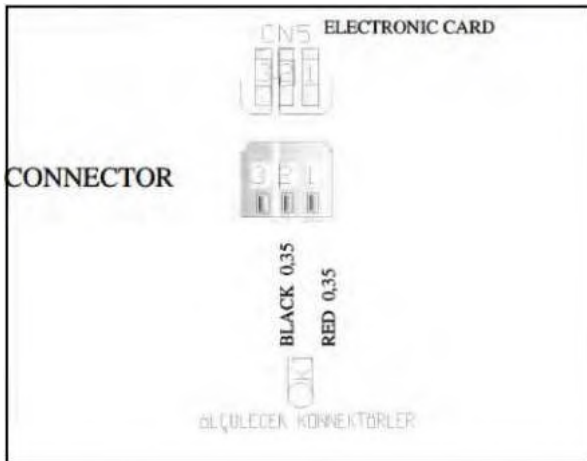

Sketch above show the connectors of the salt sensor on the electrical card. Probes of the tester should be applied on the related connectors.

From the component:



salt sensor can also be measured from the water softener when the salt sensor is assembled on the water softener.

Probes of the tester should be applied on to the related connectors as shown on the pictures.

# DIVERTER

From the electrical Card:

	C	T
DIVERTER	CN 6.1 - CN 2.9 10500 ± %7 Ω	KN 6.1 - KN 2.8 10500 ± %7 Ω

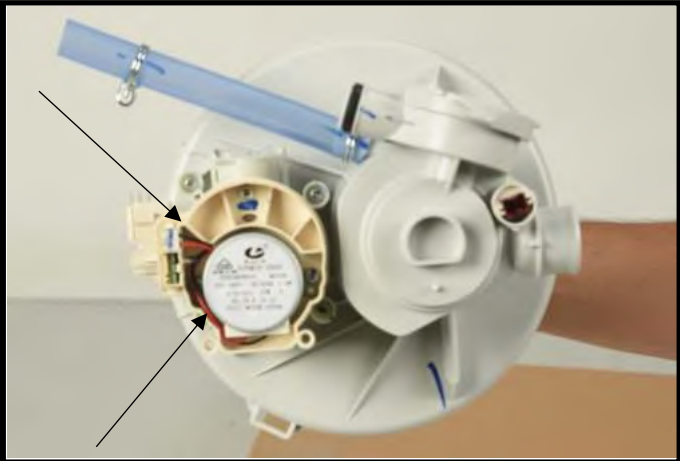
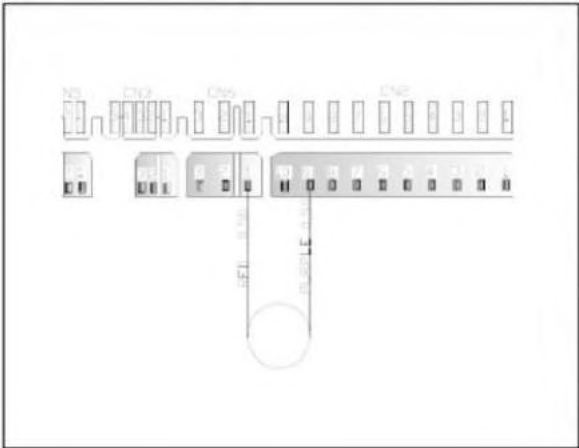

Sketch above show the connectors of the diverter on the electrical card. Probes of the tester should be applied on to the related connectors.

From the component:



Probes of the tester should be applied on to the related connectors as shown on the pictures.

# DISASSEMBLY

**CAUTION!:** REMOVE ELECTRIC PLUG FROM THE SOCKET DURING THE DISASSEMBLY

## Top Plate

- a) Remove two screws that fix the top plate at the back.
- b) Push the top-plate back and pull it up.



## Plastic Kick Plate

- a) Remove two screws fixing plastic kick plate.



- b) Remove the plastic kick plate as it is shown in the picture.



## INTERNAL FEEDING TUBES AND SPRAY ARMS REMOVAL

1) Unscrew the feed channel tabs with the help of a screwdriver



2) To assemble, manually narrow the feed channel replacement and insert it into the tabs

3) Pull out the top spray channel by turning it clockwise

4) Turn it counterclockwise to reinstall it

5) To remove the lower spray arm, kindly pull it up



## The components that are inside the tub course, micro and metal filters

- a) Open the door.
- b) Remove lower basket
- c) To remove microfilter group rotate them in the direction of counter clockwise and pull them up as it is shown in the picture



- d) To remove microfilter group (course filter and micro filter ) pull them as it is shown in the picture.



- e) To remove the metal filter pull it up as it shown in the picture.



## Draining hose



- a) Remove the hose connection plastic.
- b) Remove lower cover.
- c) Remove the clamp that fixes draining hose to the sump
- d) Remove draining hose

## Lower basket



- a) Open machine's door.
- b) Pull the basket to yourself.

## Upper basket



- a) Open upper basket rail lock front.
- b) Pull the basket to yourself and remove it.



## Water Inlet valve

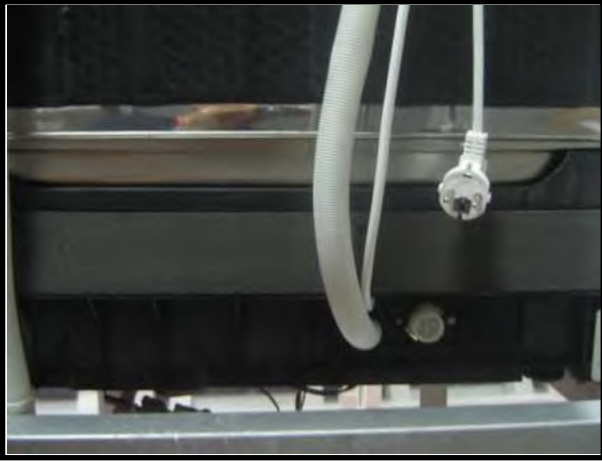

a) Remove lower cover.



b) Remove the wire that is connected to the water inlet valve.

c) Remove the clamp that connects water inlet valve and air-break as it is shown in the picture

To remove water inlet valve pull it back as it is shown in the direction of picture then release water inlet valve from the pins that is connecte to and rotate it in the direction of counterclockwise.



## TURBO FAN REMOVAL INSTRUCTIONS

1) Remove top tray



3) Disconnect the condensate unit from the turbo fan.



2) Remove the side panel rear and front screws



side panel rear screw

4) Remove the turbo fan screws



turbo fan screws

5) Disconnect turbo fan cables

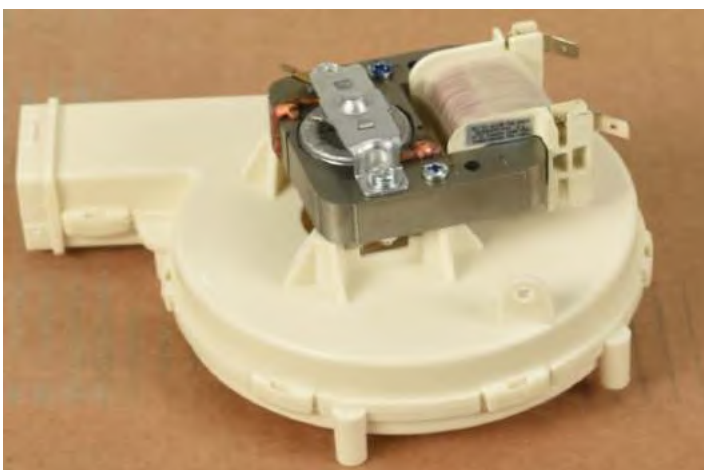

6) Remove the turbo fan from its replacement + to reassemble, Before connect the cables, Install the screws, install the condensate unit

**5)Disconnect ntc cables**

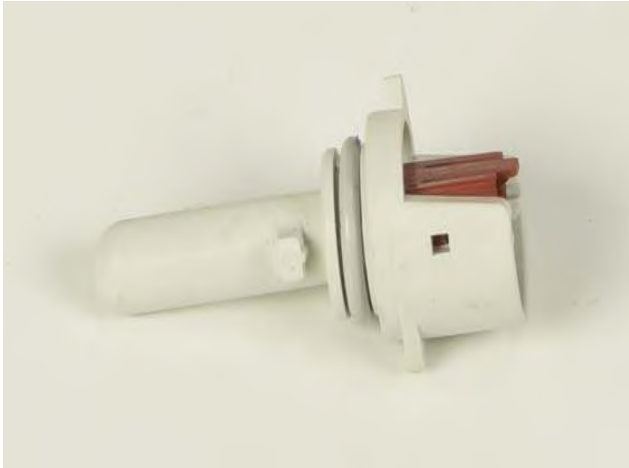

**NTC**

**6)Disconnect heater hose**

**7)Unscrew eco or diverter part(it is changeable) screws**

**8)Then get the sump**



**To assemble, connect the cables and screws in same way.**

## SUMP GROUP REMOVAL INSTRUCTIONS

1) Remove 2 screws on top



sump screws

2) Remove the drain pump



drain pump

3) Remove the drain hose



drain hose

4) Remove the blue hose from the water softener to the pool group



blue hose

## HEATER REMOVAL INSTRUCTIONS

1) Remove 2 clamps



2) Disconnect cable connections and get the heater

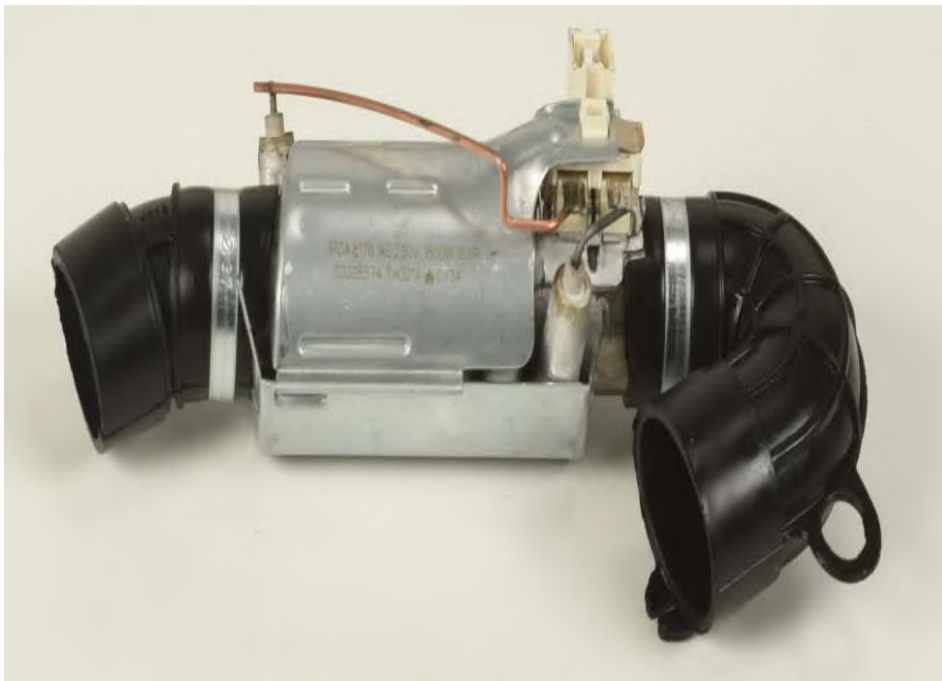

3) To assemble, the cables are connected first and the screws are attached.

## Floater



a) Remove lower cover.



b) Remove two screws that fix floater as it is shown in the picture.



c) Remove the two floater hoses.

d) Remove the wire that is connected to the floater.

## Water softener



a) To remove salt cup cover, rotate it in the direction of counterclockwise

b) To remove salt cup nut, rotate it in the direction of counterclockwise.

c) Remove left side panel.

d) Derach the connections which are between water softener and air-break.

e) Remove lower cover.

f) Remove the hose that is between sump and salt camp.



## Parasite filter



a) Remove lower cover.

b) Remove one screw fixing parasite filter.

c) Remove wires.

d) Push parasite filter and remove it.

## DIVERTER REMOVAL INSTRUCTIONS

1) Disconnect the diverter cables



diverter cables

2) Disconnect pressure switch cables

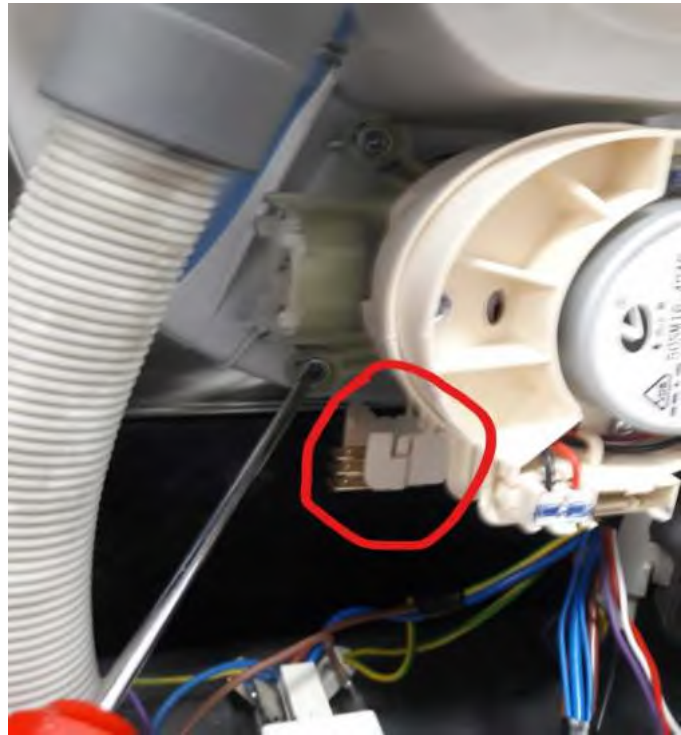

pressure switch

3) Disconnect turbidity sensor cables( if the machine has)

4) Unscrew the diverter screws

5) Pull the clamps with pliers (**Diverter clamp is next to the circulation pump's clamp. you can see in the circulation pump removal instruction page).**

## Access the components from the lower cover

a) Lay the appliance on the rear panel.



b) Remove lower cover from the places that are shown in the picture.

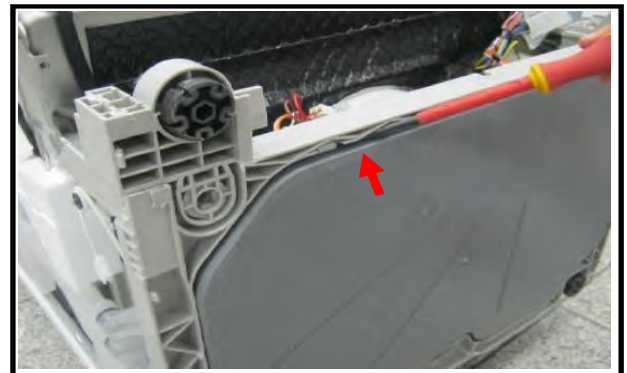

## CIRCULATION PUMP REMOVAL INSTRUCTIONS

1) There are 2 clamps.

3) remove the straps from both sides

2) Push the 2 clamps upwards.



pushing the clamps upwards

## To access the components from in Front of the Machine



- a) Remove plastic kick plate iron sheet and basement front cover

## Regeneration valve

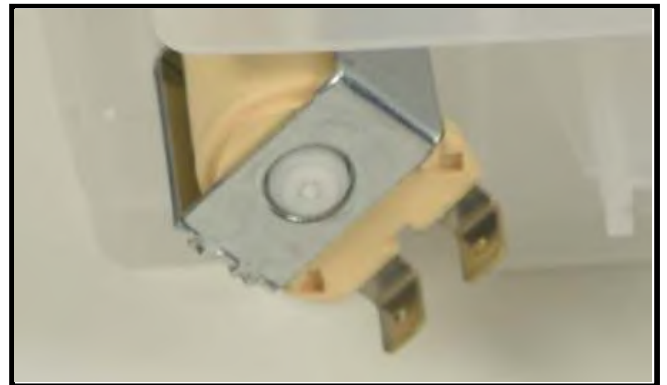

- a) Remove plastic kick plate and kick plate iron sheet.
- b) Remove the wires
- c) To remove regeneration Value rotate counterclockwise and pull it as it is shown in the picture.

## Drain pump



- a) Remove plastic kick plate and kick plate iron sheet
- b) Remove the wires.
- c) To remove the drain pump that fixes to the sump, rotate it in the direction of counterclockwise and pull.

## Power cord

- a) Remove hose connection plastic.



- b) Remove the lower cover.
- c) Remove the wires that is between power cord and parasite filter.
- d) Remove the power cord.



## Hose connection plastic



a) Remove left side panel.



b) By using flat tip screwdriver remove hose connection plastic's hinge from the basement as it shown in the picture



c) Push the hose connection plastic.

**Warning:** If you do not obey instructions while disassembly of the hose connection plastic it can be broken.

## Air - break



a) Remove the left side panel of the machine.

b) Open machine's door

c) Rotate counterclockwise air-break nut and remove it.

d) Remove air-break's connections with salt cap as it is shown in the picture. (be careful about plastic hinges)



## Door Inside

- a) Remove side panels.
- b) Remove Hinge Spring.



Door spring

- c) Pull the door inside up as It is shown in the picture.
- d) Remove two screws that fix hinge movement sheet iron to the door inside.



## KNOB REMOVAL INSTRUCTIONS



- 1) Remove control panel,
- 2) Remove the pcb box,
- 3) Remove the plastic tabs around the knob by flexing them.

# DISPANSER REMOVAL INSTRUCTIONS

1) Remove front panel

2) Disconnect the dispenser cable harness



Dispanser cables

4) Then the dispenser will drop in



dispanser is free

3) Remove the metal tabs on the top, bottom and sides to disengage the dispenser.



metal tabs on the top

5) To assemble, tighten the metal tabs with a pliers

6)

After applying silicone oil or liquid soap to dispenser, press down and engage dispenser.

pressing to the dispanser down



## DOOR LOCK REMOVAL INSTRUCTIONS

1) Remove control panel screws



2) Disconnect cable connections with door lock



3) Remove two door lock screws



## ELECTRONIC CARD REMOVAL INSTRUCTIONS

1) Remove top tray



3) Remove side panel



3) Remove side panel support styrofoam

4) Pull up the pcb box



5) Disconnect cable connections from cable harness

6) Remove the tabs and take the electronic card

7) To assemble, reinsert the pcb box into the tabs.

## Control Panel

- a) Remove 6 screws that fix control panel to the door inside sheet iron.
- b) Remove the control panel group carefully as shown in the picture



- c) Remove the cable connection plastic which fix cable harness to the control panel as shown in the picture.
- d) Remove the wires that are connected to control panel group.

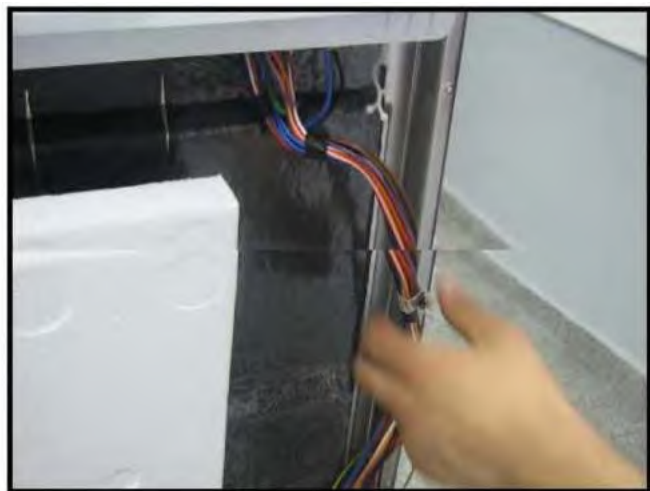

## Control Panel

- a) Remove 6 screws that fix control panel to the door inside sheet iron.
- b) Remove the control panel group carefully as shown in the picture



- c) Remove the cable connection plastic which fix cable harness to the control panel as shown in the picture.
- d) Remove the wires that are connected to control panel group.

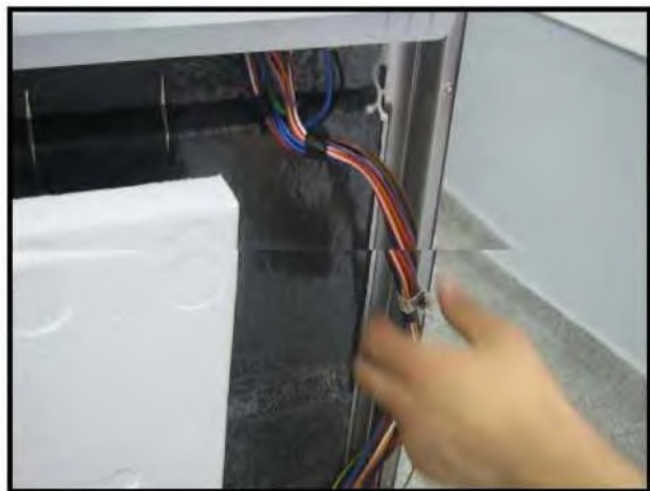

## Kick Plate Sheet Iron

- a) Remove top plate, plastic kick plate and side panels.
- b) Remove the screws (4 screws) that fix the kick plate sheet iron.
- c) Pull it down as shown in the picture.



- To remove the side panel, remove the upper plastic hinge and then the above one and pull it up.



## Front Panel

a) Remove the screws as it shown in the picture.



b) Pull down the front panel after removing the screws.

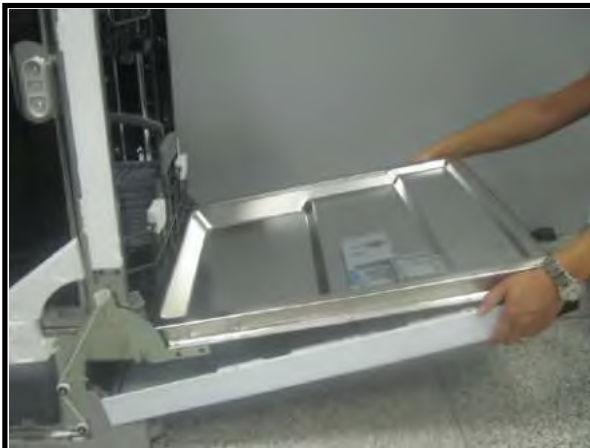

# Side panels removal instructions

1) Remove top table screws



Top Tray screws

2) Remove the side panel rear screws



Side panel rear screws

3) Remove the kick plate plastic after removing the front panel



Plastic kick plate screw

4) Remove the side panel front screws



side panel front screws

5) remove the side panel rear tabs



6) Remove the side panel front tabs

